

Public Signage Solutions



EN User Manual



TYPE NR. BDL425IV

PHILIPS

TABLE OF CONTENTS

SAFETY INSTRUCTIONS	2
Contents	8
Connection & Button Overviews	9
Terminal Panel	10
Remote Control	11
Operating Range for the Remote Control.....	12
Handling the remote control	12
How to Mount or Attach Feet to the LCD Monitor	13
Setup Procedure	16
Install the LCD Monitor in Portrait Mode	18
Connectivity	19
Connectivity Diagram.....	19
Connecting to a Personal Computer.....	20
Connecting to a Digital Interface Equipment.....	21
Connecting to a DVD Player	22
Connecting to a Stereo Amplifier	23
Connecting to a mount PC.....	23
Basic Operation	24
Power ON and OFF Modes	24
Power Indicator	25
Using Power Management	25
Display Signal of Video Source Setting to [VIDEO]	25
Picture Size	25
Smart Picture Mode.....	26
Audio Source Switching	26
Control Lock Mode	26
OSD Information.....	26
OSD (On-Screen-Display) Controls	27
PICTURE	28
SCREEN	30
AUDIO	32
PIP (PICTURE IN PICTURE)	33
CONFIGURATION 1.....	34
CONFIGURATION 2.....	36
ADVANCED OPTION	38
NOTE.....	41
Features	45
Troubleshooting.....	46
Specifications.....	48
Pin Assignment.....	49

SAFETY INSTRUCTIONS

WARNINGS AND PRECAUTIONS

KNOW THESE SAFETY SYMBOLS



CAUTION: TO REDUCE THE RISK OF ELECTRIC SHOCK, DO NOT REMOVE COVER (OR BACK). NO USER SERVICEABLE PARTS INSIDE. REFER SERVICING TO QUALIFIED SERVICE PERSONNEL.



This symbol indicates high voltage is present inside. It is dangerous to make any kind of contact with any inside part of this product.



This symbol alerts you that important literature concerning operation and maintenance has been included with this product.

Note to CATV system installer: This reminder is provided to call CATV system installer's attention to Article 820-40 of the National Electrical Code (Section 54 of Canadian Electrical Code, Part I), that provides guidelines for proper grounding and, in particular, specifies that the cable ground shall be connected to the grounding system of the building as close to the point of cable entry as practical.

Caution: FCC/CSA regulations state that any unauthorized changes or modifications to this equipment may void the user's authority to operate it.

Caution: To prevent electric shock, match the wide blade of plug to the wide slot, and fully insert the plug.

Attention: Pour éviter les chocs électriques, introduire la lame la plus large de la fiche dans la bome correspondante de la prise et pousser jusqu'au fond.

Important: One Federal Court has held that unauthorized recording of copyrighted TV programs is an infringement of U.S. copyright laws. Certain Canadian programs may also be copyrighted and any unauthorized recording in whole or in part may be in violation of these rights.

TO PREVENT DAMAGE WHICH MAY RESULT IN FIRE OR ELECTRIC SHOCK HAZARD, DO NOT EXPOSE THIS APPLIANCE TO RAIN OR MOISTURE.

The Socket-outlet shall be installed near the apparatus and shall be easily accessible.

Read and follow these instructions when connecting and using your computer monitor:



- **Unplug the monitor if you are not going to use it for an extensive period of time.**
- **Unplug the monitor if you need to clean it with a slightly damp cloth. The screen may be wiped with a dry cloth when the power is off. However, never use alcohol, solvents or ammonia-based liquids.**
- **Consult a service technician if the monitor does not operate normally when you have followed the instructions in this manual.**
- **The casing cover should be opened only by qualified service personnel.**
- **Keep the monitor out of direct sunlight and away from stoves or any other heat source.**
- **Remove any object that could fall into the vents or prevent proper cooling of the monitor's electronics.**
- **Do not block the ventilation holes on the cabinet.**
- **Keep the monitor dry. To avoid electric shock, do not expose it to rain or excessive moisture.**
- **If turning off the monitor by detaching power cable or DC power cord, wait for 6 seconds before attach the power cable or DC power cord for normal operation.**
- **To avoid the risk of shock or permanent damage to the set do not expose the monitor to rain or excessive moisture.**
- **When positioning the monitor, make sure the power plug and outlet are easily accessible.**
- **IMPORTANT: Always activate a screen saver program during your application. If a still image in high contrast remains on the screen for an extended period of time, it may leave an 'after-image' or 'ghost image' on the front of the screen. This is a well-known phenomenon that is caused by the shortcomings inherent in the LCD technology. In most cases the afterimage will disappear gradually over a period of time after the power has been switched off. Be aware that the after-image symptom cannot be repaired and is not covered under warranty.**

REGULATORY INFORMATION

CE DECLARATION OF CONFORMITY

MMD declare under our responsibility that the product is in conformity with the following standards

- EN60950-1:2006+A11:2009 (Safety requirement of Information Technology Equipment)
- EN55022:2006+A1:2007 (Radio Disturbance requirement of Information Technology Equipment)
- EN55024:1998+A1:2001+A2:2003 (Immunity requirement of Information Technology Equipment)
- EN6100-3-2: 2006 (Limits for Harmonic Current Emission)
- EN6100-3-3:1995+A1:2001+A2:2005 (Limitation of Voltage Fluctuation and Flicker)

following provisions of directives applicable

- 2006/95/EC (Low Voltage Directive)
- 2004/108/EC (EMC Directive)
- 93/68/EEC (Amendment of EMC and Low Voltage Directive) and is produced by a manufacturing organization on ISO9000 level.

FEDERAL COMMUNICATIONS COMMISSION (FCC) NOTICE (U.S. Only)



This equipment has been tested and found to comply with the limits for a Class B digital device, pursuant to Part 15 of the FCC Rules. These limits are designed to provide reasonable protection against harmful interference when the equipment is operated in a commercial environment. This equipment generates, uses and can radiate radio frequency energy and, if not installed and used in accordance with the instructions manual, may cause harmful interference to radio communications.

Operation of this equipment in a residential area is likely to cause harmful interference in which case the user will be required to correct the interference at his own expense.



Changes or modifications not expressly approved by the party responsible for compliance could void the user's authority to operate the equipment.

Use only RF shielded cable that was supplied with the monitor when connecting this monitor to a computer device.

To prevent damage which may result in fire or shock hazard, do not expose this appliance to rain or excessive moisture.

THIS CLASS B DIGITAL APPARATUS MEETS ALL REQUIREMENTS OF THE CANADIAN INTERFERENCE- CAUSING EQUIPMENT REGULATIONS.



This device complies with Part 15 of the FCC Rules. Operation is subject to the following two conditions: (1) this device may not cause harmful interference, and (2) this device must accept any interference received, including interference that may cause undesired operation.

POLISH CENTER FOR TESTING AND CERTIFICATION NOTICE

The equipment should draw power from a socket with an attached protection circuit (a three-prong socket). All equipment that works together (computer, monitor, printer, and so on) should have the same power supply source.

The phasing conductor of the room's electrical installation should have a reserve short-circuit protection device in the form of a fuse with a nominal value no larger than 16 amperes (A).

To completely switch off the equipment, the power supply cable must be removed from the power supply socket, which should be located near the equipment and easily accessible.

A protection mark "B" confirms that the equipment is in compliance with the protection usage requirements of standards PN-93/T-42107 and PN-89/E-06251.

Wymagania Polskiego Centrum Badań i Certyfikacji

Urządzenie powinno być zasilane z gniazda z przyłączonym obwodem ochronnym (gniazdo z kolkiem). Współpracujące ze sobą urządzenia (komputer, monitor, drukarka) powinny być zasilane z tego samego źródła.

Instalacja elektryczna pomieszczenia powinna zawierać w przewodzie fazowym rezerwową ochronę przed zwarciami, w postaci bezpiecznika o wartości znamionowej nie większej niż 16A (amperów).

W celu całkowitego wyłączenia urządzenia z sieci zasilania, należy wyjąć wtyczkę kabla zasilającego z gniazda, które powinno znajdować się w pobliżu urządzenia i być łatwo dostępne.

Znak bezpieczeństwa "B" potwierdza zgodność urządzenia z wymaganiami bezpieczeństwa użytkowania zawartymi w PN-93/T-42107 i PN-89/E-06251.

Pozostałe instrukcje bezpieczeństwa

- Nie należy używać wtyczek adapterowych lub usuwać kolka obwodu ochronnego z wtyczki. Jeżeli konieczne jest użycie przedłużacza to należy użyć przedłużacza 3-żyłowego z prawidłowo połączonym przewodem ochronnym.
- System komputerowy należy zabezpieczyć przed nagłymi, chwilowymi wzrostami lub spadkami napięcia, używając eliminatora przepięć, urządzenia dopasowującego lub bezzakłóceniewego źródła zasilania.
- Należy upewnić się, aby nic nie leżało na kablach systemu komputerowego, oraz aby kable nie były umieszczone w miejscu, gdzie można byłoby na nie nadeptywać lub potykać się o nie.
- Nie należy rozlewać napojów ani innych płynów na system komputerowy.
- Nie należy wpychać żadnych przedmiotów do otworów systemu komputerowego, gdyż może to spowodować pożar lub porażenie prądem, poprzez zwarcie elementów wewnętrznych.
- System komputerowy powinien znajdować się z dala od grzejników i źródeł ciepła. Ponadto, nie należy blokować otworów wentylacyjnych. Należy unikać kładzenia luźnych papierów pod komputer oraz umieszczania komputera w ciasnym miejscu bez możliwości cyrkulacji powietrza wokół niego.

ELECTRIC, MAGNETIC AND ELECTROMAGNETIC FIELDS ("EMF")

1. MMD manufactures and sells many products targeted at consumers, which, like any electronic apparatus, in general have the ability to emit and receive electromagnetic signals.
2. One of MMDs' leading Business Principles is to take all necessary health and safety measures for our products, to comply with all applicable legal requirements and to stay well within the EMF standards applicable at the time of producing the products.
3. MMD is committed to develop, produce and market products that cause no adverse health effects.
4. MMD confirms that if its products are handled properly for their intended use, they are safe to use according to scientific evidence available today.
5. MMD plays an active role in the development of international EMF and safety standards, enabling MMD to anticipate further developments in standardization for early integration in its products.

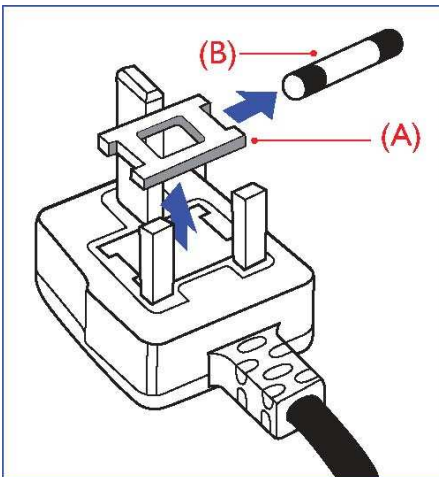
INFORMATION FOR UK ONLY**WARNING - THIS APPLIANCE MUST BE EARTHED.****Important:**

This apparatus is supplied with an approved moulded 13A plug. To change a fuse in this type of plug proceed as follows:

1. Remove fuse cover and fuse.
2. Fit new fuse which should be a BS 1362 5A, A.S.T.A. or BSI approved type.
3. Refit the fuse cover.

If the fitted plug is not suitable for your socket outlets, it should be cut off and an appropriate 3-pin plug fitted in its place.

If the mains plug contains a fuse, this should have a value of 5A. If a plug without a fuse is used, the fuse at the distribution board should not be greater than 5A.

Note: The severed plug must be destroyed to avoid a possible shock hazard should it be inserted into a 13A socket elsewhere.

How to connect a plug

The wires in the mains lead are coloured in accordance with the following code:

BLUE - "NEUTRAL" ("N")

BROWN - "LIVE" ("L")

GREEN & YELLOW - "EARTH" ("E")

1. The GREEN AND YELLOW wire must be connected to the terminal in the plug which is marked with the letter "E" or by the Earth symbol or coloured GREEN or GREEN AND YELLOW.
2. The BLUE wire must be connected to the terminal which is marked with the letter "N" or coloured BLACK.
3. The BROWN wire must be connected to the terminal which marked with the letter "L" or coloured RED.

Before replacing the plug cover, make certain that the cord grip is clamped over the sheath of the lead - not simply over the three wires.

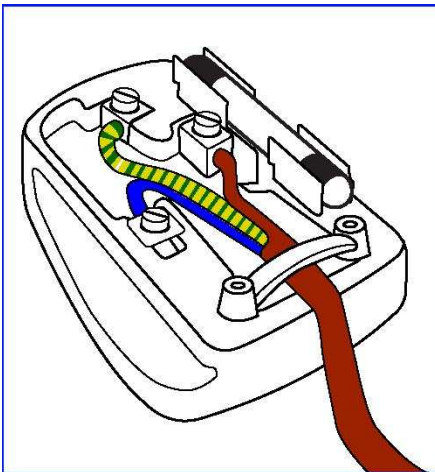

中国电子信息产品污染控制标识要求（中国RoHS法规标示要求）产品中有毒有害物质或元素的名称及含量

部件名称	有毒有害物质或元素					
	铅 (Pb)	汞 (Hg)	镉 (Cd)	六价铬 (Cr 6+)	多溴联苯 (PBB)	多溴二苯醚 (PBDE)
外壳	○	○	○	○	○	○
液晶面板	×	×	○	○	○	○
电路板组件	×	○	○	○	○	○
附件 (遥控器, 电源线, 连接线)	×	○	○	○	○	○
遥控器电池	×	○	○	○	○	○

○：表示该有毒有害物质在该部件所有均质材料中的含量均在SJ/T11363-2006 标准规定的限量要求以下。

×：表示该有毒有害物质至少在该部件的某一均质材料中的含量超出 SJ/T11363-2006 标准规定的限量要求。



环保使用期限

此标识指期限(十年)，电子信息产品中含有的有毒有害物质或元素在正常使用的条件下不会发生外泄或突变，电子信息产品用户使用该电子信息产品不会对环境造成严重污染或对其人身、财产造成严重损害的期限。

NORTH EUROPE (NORDIC COUNTRIES) INFORMATION

Placering/Ventilation

VARNING:

FÖRSÄKRA DIG OM ATT HUVUDBRYTARE OCH UTTAG ÄR LÄTÅTKOMLIGA, NÄR DU STÄLLER DIN UTRUSTNING PÅPLATS.

Placering/Ventilation

ADVARSEL:

SØRG VED PLACERINGSFOR, AT NETLEDNINGENS STIK OG STIKKONTAKT ER NEMT TILGÆNGELIGE.

Paikka/Ilmankierto

VAROITUS:

SIJOITA LAITE SITEN, ETTÄ VERKKOJOHTO VOIDAAN TARVITTAESSA HELPOSTI IRROTTAA PISTORASIESTA.

Plassering/Ventilasjon

ADVARSEL:

NÅR DETTE UTSTYRET PlassERES, MÅ DU PASSE PÅ AT KONTAKTENE FOR STØMTILFØRSEL ER LETTE Å NÅ.

END-OF-LIFE DISPOSAL

Your new TV/Monitor contains materials that can be recycled and reused. Specialized companies can recycle your product to increase the amount of reusable materials and to minimize the amount to be disposed of.

Please find out about the local regulations on how to dispose of your old monitor from your local Philips dealer.

(For customers in Canada and U.S.A.)

This product may contain lead and/or mercury. Dispose of in accordance to local-state and federal regulations. For additional information on recycling contact www.eia.org (Consumer Education Initiative)

WASTE ELECTRICAL AND ELECTRONIC EQUIPMENT-WEEE**Attention users in European Union private households**

This marking on the product or on its packaging illustrates that, under European Directive 2002/96/EG governing used electrical and electronic appliances, this product may not be disposed of with normal household waste. You are responsible for disposal of this equipment through a designated waste electrical and electronic equipment collection. To determine the locations for dropping off such waste electrical and electronic, contact your local government office, the waste disposal organization that serves your household or the store at which you purchased the product.

Attention users in United States:

Like all LCD products, this set contains a lamp with Mercury. Please dispose of according to all Local, State and Federal Laws. For the disposal or recycling information, contact: www.mygreenelectronics.com or www.eiae.org.

**END OF LIFE DIRECTIVES-RECYCLING**

Your new TV/Monitor contains several materials that can be recycled for new uses.

Like all LCD products, this set contains a lamp with Mercury, please dispose of according to all Local, State and Federal laws.

Contents

The **BDL4251V** monitor pack* should include:

- LCD monitor
- Power cord (1.8 m)
- VGA Signal Cable (1.8 m)
- CD User Manual & QSG
- Remote Control and AAA Batteries
- Cable belt x 3 (For tightening cables)

- Main switch cover
- Screw for Main Switch cover x 2
- BNC TO RCA adapter x 5
- Logo guider
- Clamper
- Screw for Clamper x 2

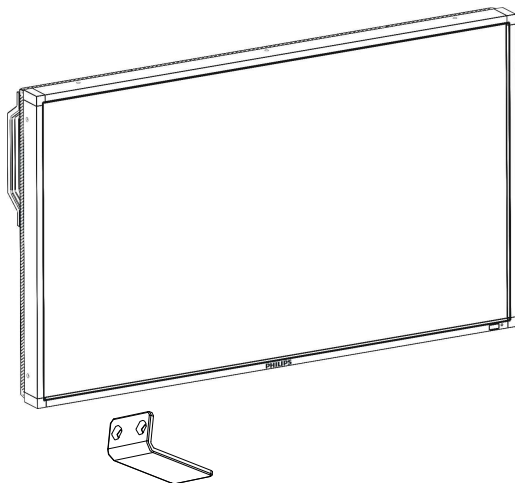

Main switch cover

* The supplied power cord varies depending on destination.



Power cord

* Please make sure that for all other regions, apply a power cord that conforms to the AC voltage of the power socket and has been approved by and complies with the safety regulations of the particular country.

* You might like to save the package box and packing material for shipping the monitor.

* The following components are prepared as options.

- External Speakers
- Table stand

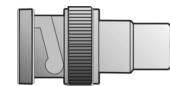
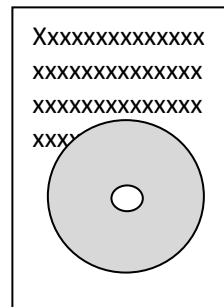

BNC TO RCA adapter x 5



Screw for Main switch cover (M3 x 6) x 2



Screw for Clamper (M4 x 8) x 2

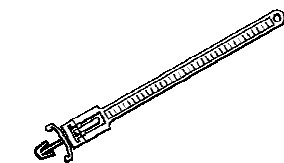

Cable belt x 3 (For tightening the power cord and VGA / HDMI cable)

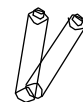
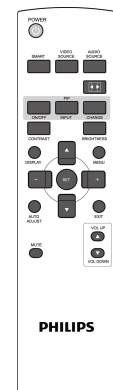

Remote Control and AAA Batteries



Clamper

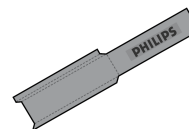

Logo guider

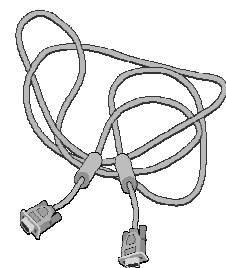

Video Signal Cable (D-SUB to D-SUB Cable)

Connection & Button Overviews

Control Panel

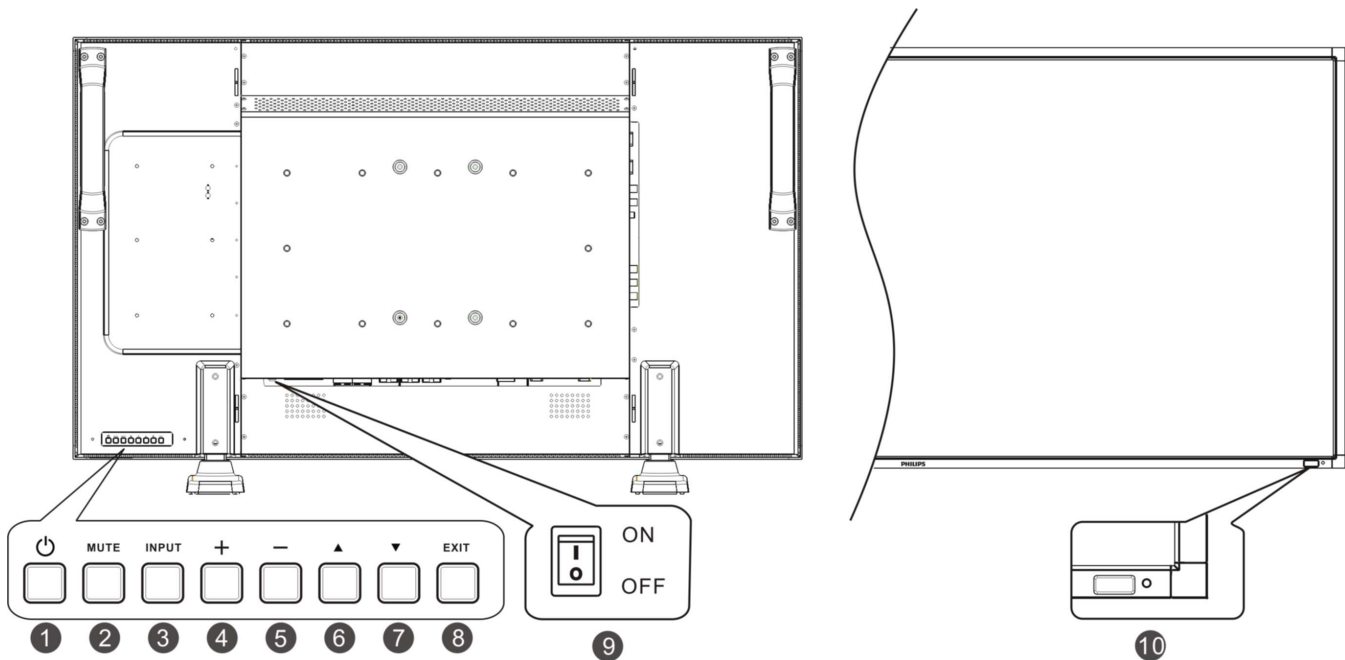

- ❶ **POWER button (⏻)** : To switch the power on/off.
- ❷ **MUTE button** : To switch the audio mute ON/OFF.
- ❸ **INPUT button** : To set the function while OSD menu is on or to activate input selection menu while OSD menu is off.
- ❹ **PLUS (+) button** : To increase the adjustment while OSD menu is on, or to increase the audio output level while the OSD menu is off.
- ❺ **MINUS (-) button** : To decrease the adjustment while OSD menu is on, or to decrease the audio output level while the OSD menu is off.
- ❻ **UP (▲) button** : To move the highlight bar up to adjust the selected item while OSD menu is on, or to activate the OSD menu when the OSD menu is off.
- ❼ **DOWN (▼) button** : To move the highlight bar down to adjust the selected item while OSD menu is on, or to activate the OSD menu when the OSD menu is off.
- ❽ **EXIT button** : To return to previous menu while OSD menu is on or to activate the OSD menu when the OSD menu is off.
- ❾ **Main Power Switch** : To turn the main power on/off.
- ❿ **Remote control sensor, Power indicator and ambient light sensor** : To receive the IR signal from the remote control. The indicator would show green when the LCD monitor is active and would turn red when the LCD is POWER OFF. While in the case of the system is in power save mode, it would show both green and red. When SCHEDULE is enabled, it would blink green and glow red. If the indicator blinks red, it tells that a failure is detected. The image brightness will be auto adjusted when "LIGHT SENSOR" set to "ON" on OSD menu.

NOTE: Keyboard Control Lock Mode This function completely disables the access to all Keyboard Control functions. To enable the keyboard control lock, press both of "▲" and "▼" buttons and hold down continuously for more than 3 seconds. To recover back to the user mode, press both of "▲" and "▼" and hold continuously for three 3 seconds.

Terminal Panel

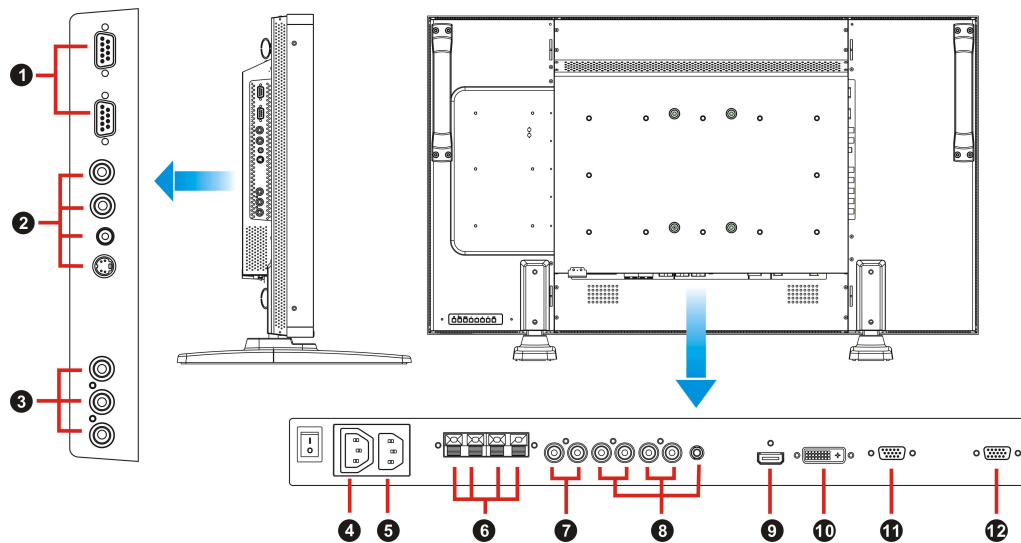

❶ EXTERNAL CONTROL (mini D-Sub 9 pin)

This is for serial connection when multiple BDL4251V monitors are connected. To achieve remote management through RS232C commands (refer to the RS232C remote control user manual), connect the RS232C OUT connector from a computer or from a different BDL4251V monitor to the RS232C IN connector from your BDL4251V monitor. The same RS232C commands can be looped through by connecting the RS232C OUT of this monitor to the next RS232C IN.

❷ VIDEO IN/OUT

VIDEO IN connector (BNC and RCA): To input a composite video signal. Note that BNC and RCA are not available at the same time.

VIDEO OUT connector (BNC): To output the composite video signal from VIDEO IN connector.

S-VIDEO IN connector (MINI DIN 4 pin): To input the S-video (Y/C separate signal).

❸ COMPONENT IN [Y, Pb, Pr] (BNC)

To connect an equipment such as a DVD player, HDTV device, or Laser disc player.

❹ AC OUT connector

Bypass AC power output from AC IN connector. (Rating : 100~240Vac, 50-60Hz, 3A Max.)

❺ AC IN connector

To connect with the supplied power cord.

❻ EXTERNAL SPEAKER TERMINAL

To output the audio signal to external speakers from AUDIO IN 1, 2, 3 jack or HDMI.

❼ AUDIO OUT

To output the audio signal from the AUDIO IN 1, 2 and 3 jack or HDMI.

❽ AUDIO IN 1, 2, 3

To input audio signal from external equipment such as a computer, VCR or DVD player.

❾ HDMI IN

To input digital video/audio signals from a digital equipment or computer.

❿ DVI-D IN

To input digital video signals from a digital equipment or computer.

⓫ VGA IN (mini D-Sub 15 pin)

To input analog RGB signals from a computer or other RGB equipment.

⓬ VGA OUT (mini D-Sub 15 pin)

To output the signal from VGA IN.

Remote Control

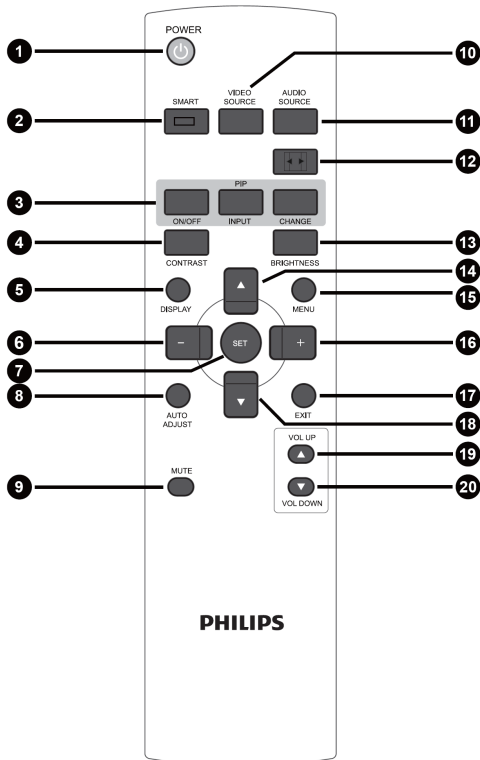

❶ POWER button

To turn the power on/off.

If LED Power Indicator on the monitor is not lightening, then the remote control will not work.

❷ SMART PICTURE button

To select smart picture mode from [HIGHBRIGHT], [STANDARD], [sRGB], [CINEMA].

HIGHBRIGHT: for moving image such as Video

STANDARD: for images (Factory setting)

sRGB: for text based images

CINEMA: for movies.

❸ PIP (Picture In Picture) button

ON/OFF button: To turn PIP mode ON/OFF.

INPUT button: To select the input signal for the sub-picture.

CHANGE button: To exchange between the main picture and sub-picture.

Note:

The "PIP" and "POP" modes do not work if the screen size is "CUSTOM", "DYNAMIC" or "REAL".

❹ CONTRAST button

To start **CONTRACT** OSD selection, and then push "+" or "-" button to adjust the value.

❺ DISPLAY button

To turn on/off the setting information displayed on the right-up corner of the screen.

❻ MINUS button

To decrease the adjustment with OSD menu.

To move the sub-picture left when in "PIP" mode.

❼ SET button

To activate the setting with OSD menu.

❽ AUTO ADJUST button

To execute the AUTO ADJUST function.

❾ MUTE button

To turn the mute function on/off.

❿ VIDEO SOURCE button

To activate input selection menu, and push "▲" or "▼" to select input source from [HDMI], [DVI-D], [VGA],[COMPONENT], [S-VIDEO] and [VIDEO], and then push "SET" to switch to selected input source.

⓫ AUDIO SOURCE button

To activate audio selection menu, and push "▲" or "▼" to select audio source from [AUDIO1], [AUDIO2], [AUDIO3] and [HDMI], and then push "SET" to switch to selected audio source.

⓬ SIZE button

To select the picture size from [FULL], [NORMAL], [CUSTOM], [DYNAMIC] and [REAL].

⓭ BRIGHTNESS button

To start the **BRIGHTNESS** OSD selection, and then push "+" or "-" button to adjust the value.

⓮ UP button

To move the highlight bar up to adjust the selected item when OSD menu is on.

To move the sub-picture up when in "PIP" mode.

⓯ MENU button

To turn the OSD menu on/off.

⓰ PLUS button

To increase the adjustment with OSD menu.

To move the sub-picture right when in "PIP" mode.

⓱ EXIT button

To turn to the previous OSD menu.

⓲ DOWN button

To move the highlight bar down to adjust the selected item when OSD menu is on.

To move the sub-picture down when in "PIP" mode.

⓳ VOLUME UP button

To increase the audio output level.

⓴ VOLUME DOWN button

To decrease the audio output level.

Operating Range for the Remote Control

Point the top of the remote control towards the LCD monitor's remote sensor during button operation.

Use the remote control within a distance of about 7 m/ 23 ft from the front of the LCD monitor's remote control sensor and within a horizontal and vertical angle 30° with a distance of about 3 m/ 10 ft.

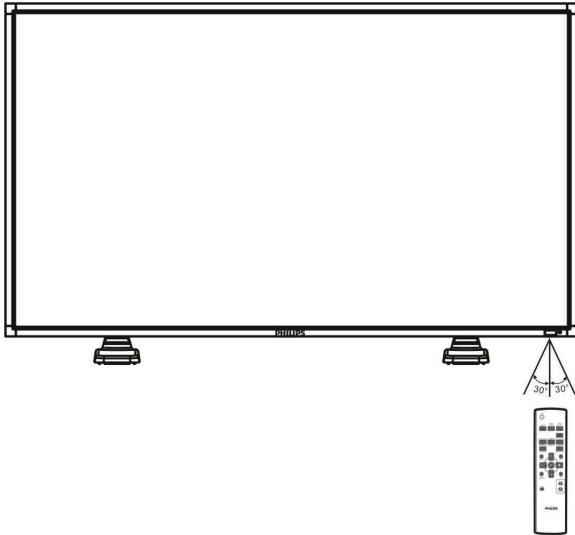

NOTE:

The remote control system may not function when direct sunlight or strong illumination strikes the remote control sensor of the LCD monitor, or when there is an obstacle in the radiation path.

Handling the remote control

- * Do not subject to strong shock.
- * Do not allow water or other liquid to splash the remote control. If the remote control gets wet, wipe it dry immediately.
- * Avoid exposure to heat and steam.
- * Other than to install the batteries, do not open the remote control.

How to Mount or Attach Feet to the LCD Monitor

You can install the LCD monitor in one of the following two ways:

Method 1: Attach and remove the optional stands

How to install stands

1. Please turn the monitor off.
2. After inserting stand in guide block, fasten the thumbscrews on both sides of the monitor.

NOTE:

Install the table stand with the longer end of the feet directing to the front.

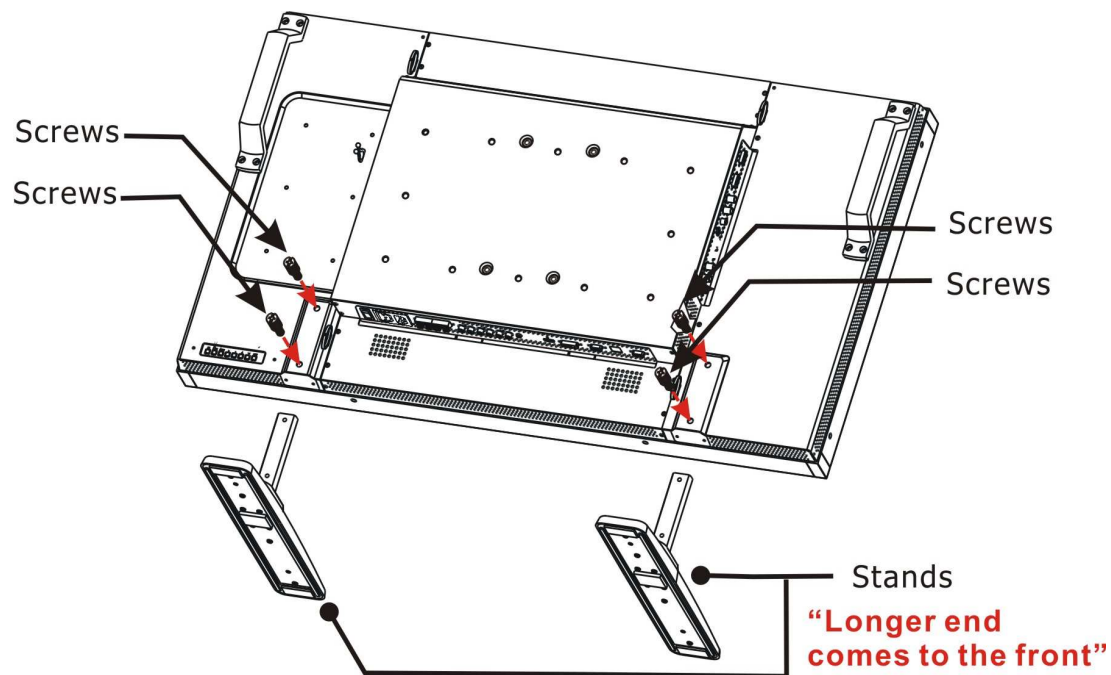

In the upright position

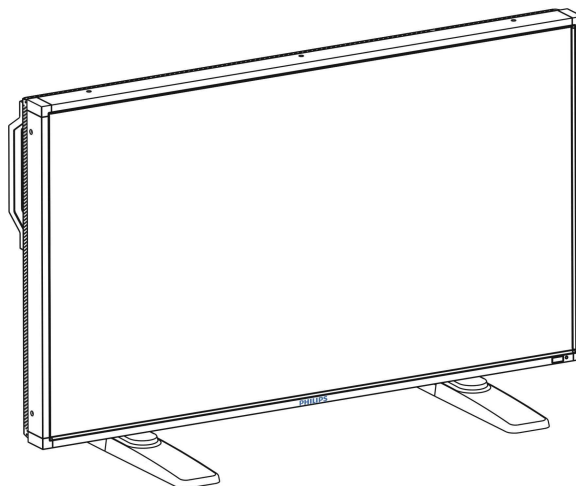

How to remove the stands

1. Spread the protective sheet on the flat surface.
2. Make the monitor lying on the protective sheet.
3. Remove screws using a screwdriver and place them in a safe place for reuse.

To avoid monitor from falling

Take measures to prevent the monitor from falling over in case of an earthquake or other disaster might occur to lessen the probability of injury and damage.

As shown in the figure below, secure the monitor to a solid wall or pillar using rope (commercially available) strong enough to bear the weight of the monitor(BDL4251V: approx. 47.5 kg). Screw hooks (commercially available), of ring type rather than C-shaped screw hooks (with opening), are recommended.

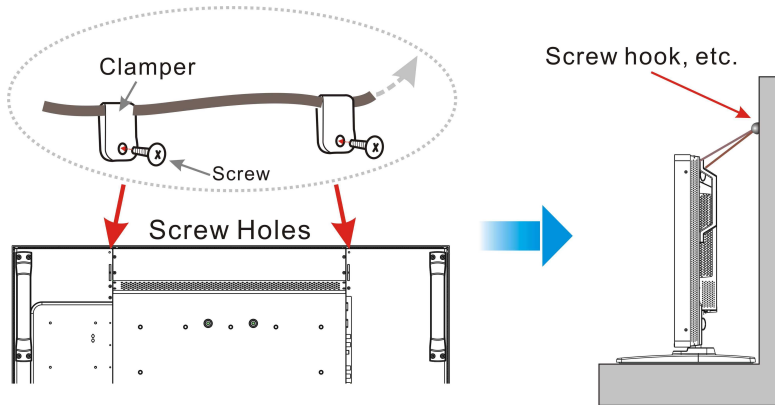

Screw here is not supplied.

Caution:

- Though the recommended prevention from falling is intended to lessen the probability of injury and damage, it doesn't assure its effectiveness against any kind of earthquake or disaster.
- Before moving the monitor, remove the rope that is securing the monitor.

Method II: Mount the monitor on the wall

Before mounting the monitor to the wall, make sure that the system has been power-off and you have obtain a standard wall-mounting kit (commercially available). Using mounting interface that comply with TÜV-GS and/or ULI678 standard in North America is recommended.

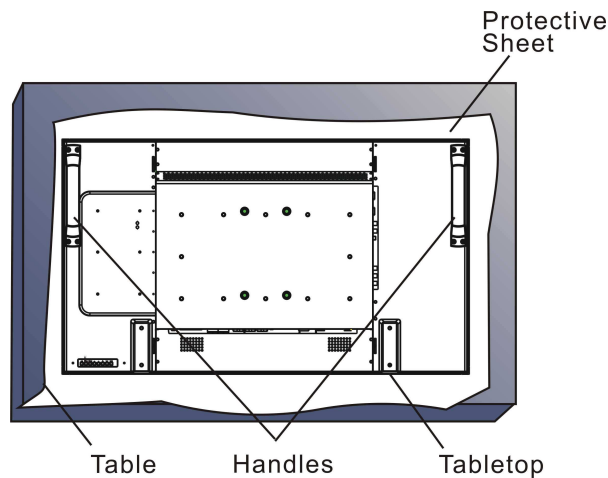

1. Lay a protective sheet on a table, which was wrapped around the monitor when it was packaged, beneath the surface as not to scratch the screen face.
2. This device cannot be installed without the correct and complete mounting accessories (not provided in the box). Make sure you have all related parts available for wall mounting.
3. Follow the instructions that come with the base mounting kit. Failure to follow correct mounting procedures could result in damage to the equipment or injury to the user or installer. Product warranty does not cover damage caused by improper installation.
4. For the wall-mounting kit, use M6 mounting screws for 400x 400 mm pattern (having a length 10 mm longer than the thickness of the mounting bracket) and tighten them securely. (Recommended torque: 470 - 635N•cm).

Caution:

- For preventing the monitor from falling.
- Install the monitor with metal brackets for wall or ceiling installation (commercially available) on your own responsibility. For detailed procedures of installation, refer to the instructions of the metal brackets.
- To lessen the probability of injury and damage resulting from fall of the monitor in case of earthquake or other disaster, be sure to consult the bracket manufacturer for installation location.
- To lessen the risk of falling of the monitor, thread commercially available rope (having a load capacity at least 1960N (200kgf)) through the handles at the right and left of the monitor and secure the rope to the wall mount brackets or ceiling mount brackets.(Refer to the first paragraph of this page.)

Ventilation Requirements for enclosure locating

To allow heat to disperse, leave space between surrounding objects as shown in the diagram below.

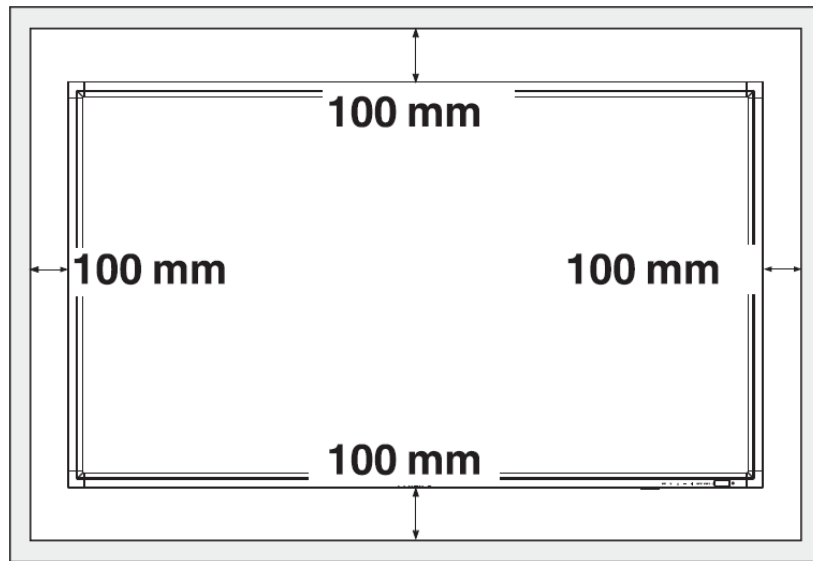

Setup Procedure

1. Install the system on the right location

CAUTION:

THE LCD MONITOR MUST BE MOVED OR INSTALLED BY TWO OR MORE PERSONS.

Failure to follow this caution may result in injury and damage when the LCD monitor falls.

CAUTION:

DO NOT ATTEMPT TO INSTALL THE LCD MONITOR BY YOURSELF.

The LCD display must be installed by a qualified technician. Contact your dealer for more information.

CAUTION:

DO NOT MOUNT OR OPERATE THE DISPLAY UPSIDE DOWN, FACE UP OR FACE DOWN. IT'S POSSIBILITY TO CLOCKWISE 90 DEGREES MOUNT. BUT DO NOT COUNTERCLOCKWISE 90 DEGREES MOUNT.

CAUTION:

DO NOT INSTALL THE LCD MONITOR WHERE IT WILL BE EXPOSED TO DIRECT SUNLIGHT.

Failure to follow this caution will result in display defects.

IMPORTANT:

Lay the protective sheet, which was wrapped around the LCD monitor when it was packaged, beneath the LCD monitor so as not to scratch the panel.

2. Install the remote control batteries

The remote control is powered by 1.5V AAA batteries. To install or replace batteries:

1. Press and slide to open the cover.
2. Align the batteries according to the (+) and (-) indications inside the case.
3. Replace the cover.

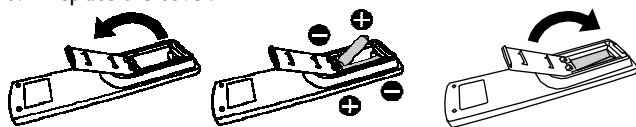

CAUTION:

Incorrect use of batteries can result in leaks or bursting. Be careful especially about the following points.

- Place "AAA" batteries matching the + and - signs on each battery to the + and - signs of the battery compartment.
- Do not mix battery types.
- Do not combine new batteries with used ones. It causes shorter battery life or leakage of batteries.
- Remove dead batteries immediately to prevent battery liquid from leaking into the battery compartment. Don't touch exposed battery acid, it cause damage to your skin.

NOTE:

If you do not intend to use the Remote Control for a long period, remove the batteries.

3. Connect to external equipment

- To protect the connected equipment, turn off the main power before making connections.
- Please refer to section "Connectivity" P.18~P.22 for operations..

4. Connect power cord

- The power outlet socket should be installed as near to the equipment as possible, and should be easily accessible.
- Fully insert the prongs into the power outlet socket. A loose connection may cause malfunctioning of the device.

NOTE:

Please refer to "Safety Operation" section of this manual for proper selection of AC power cord.

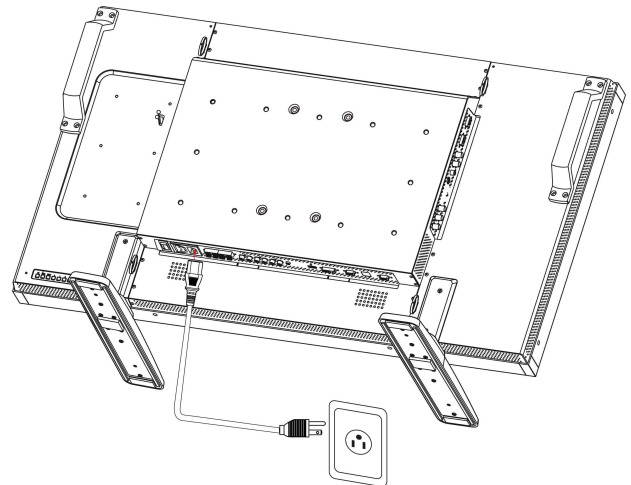

5. Turn on the power of the attached external equipment

When connected with a computer, turn on the power of the computer first.

6. Operate the attached external equipment

Display the signal from the external equipment by selecting the correct video and audio sources first.

7. Adjust the sound

Make adjustments to lower or to rise the volume as required.

8. Adjust the screen

Make adjustments to the display position or settings if required.

9. Adjust the image

Make adjustments to brightness or contrast if required.

10. Recommended Adjustment

To reduce the risk of “image persistence”, please adjust the following items based on the application being used.

“POWER SAVE”, “PANEL SAVING”, “DATE AND TIME”.

11. To prevent the main power switch from being changed

To prevent the possibility of main power switch being carelessly pushed, please attach the main switch cover (accessory) onto it.

NOTE:

With the main power switch cover in place, the main power switch can not be turned off. Remove main power switch cover in order to turn off the display.

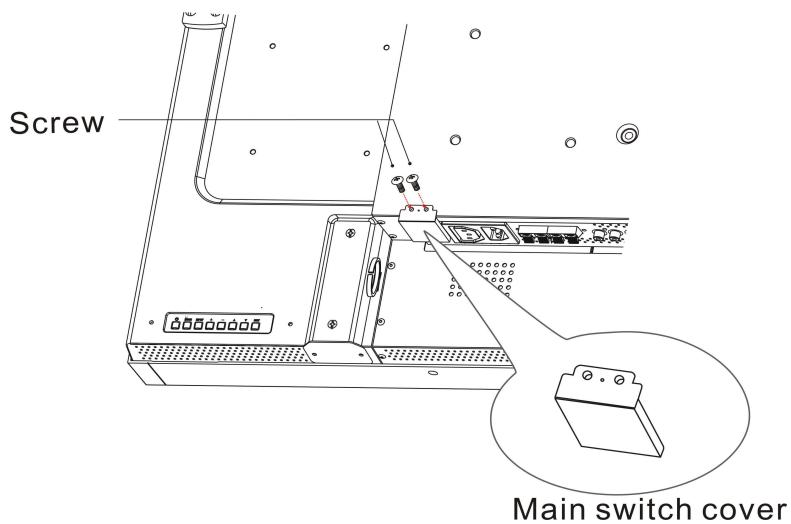

Install the LCD Monitor in Portrait Mode

BDL4251V can be installed in portrait position, under the following conditions:

Caution:

Portrait mode is effective only when wall-mounted or ceiling-mounted. The feet can not be used for the monitor in portrait position.

Placing the monitor in portrait position, will shorten the average life of the LCD backlight.

Operational Environment (Temperature) shall be limited, as shown below:

Operational	Temperature	5 - 35 °C / 41 - 95 °F
Environment	Humidity	20 - 80 % (without condensation)

Please orientate the monitor in the direction shown as the right figure:

Do not place monitor in landscape in any other manner.

How to set-up

1. Remove the feet if they are attached.
2. The "PHILIPS" logo should be on the LEFT side when facing the monitor.

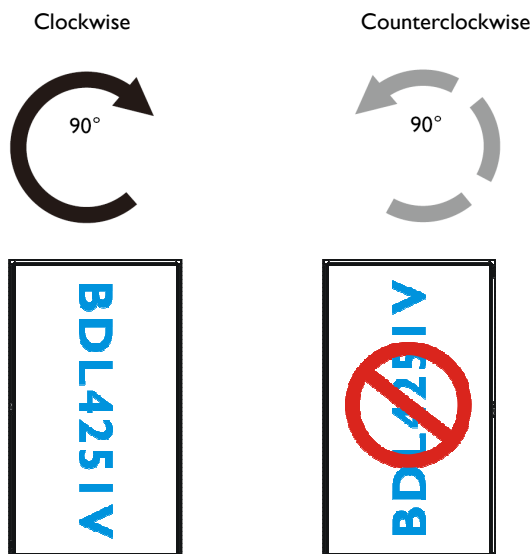

How to Remove the Logo for landscape mode?

1. Remove the logo sticker by forcing a piece of paper under the logo.
2. Using a knife, carefully remove the logo sticker with the paper placing beneath.
3. Tear off the logo sticker.

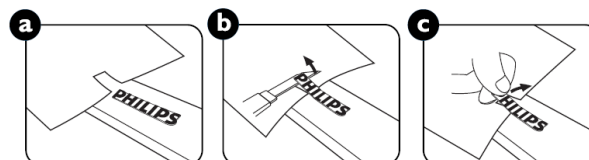

How to Use the Logo Guider for Portrait Mode?

1. Before applying, make sure the guider is well shaped. The "PHILIPS" sticker attached on the end of it could be folded back as figure a.
2. Turn back the logo end of the guider and remove the sticky tape of the logo.
3. Slide the logo guider along the short side of the front bezel as figure c & then re-turn the logo end of the guider back to the right side.
4. With your left hand fixing the guider, press the logo by your right hand to make it stuck firmly on the front bezel.
5. Remove the guider and leave the logo on the front bezel.

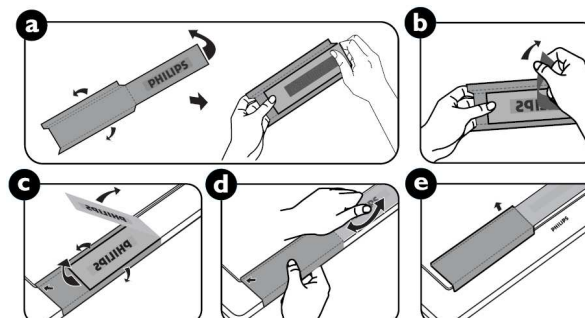

Connectivity

Before making connections:

- * First turn off the power of all the attached equipments before make connections.
- * Refer to the user manual included in each separate piece of equipment.

Connectivity Diagram

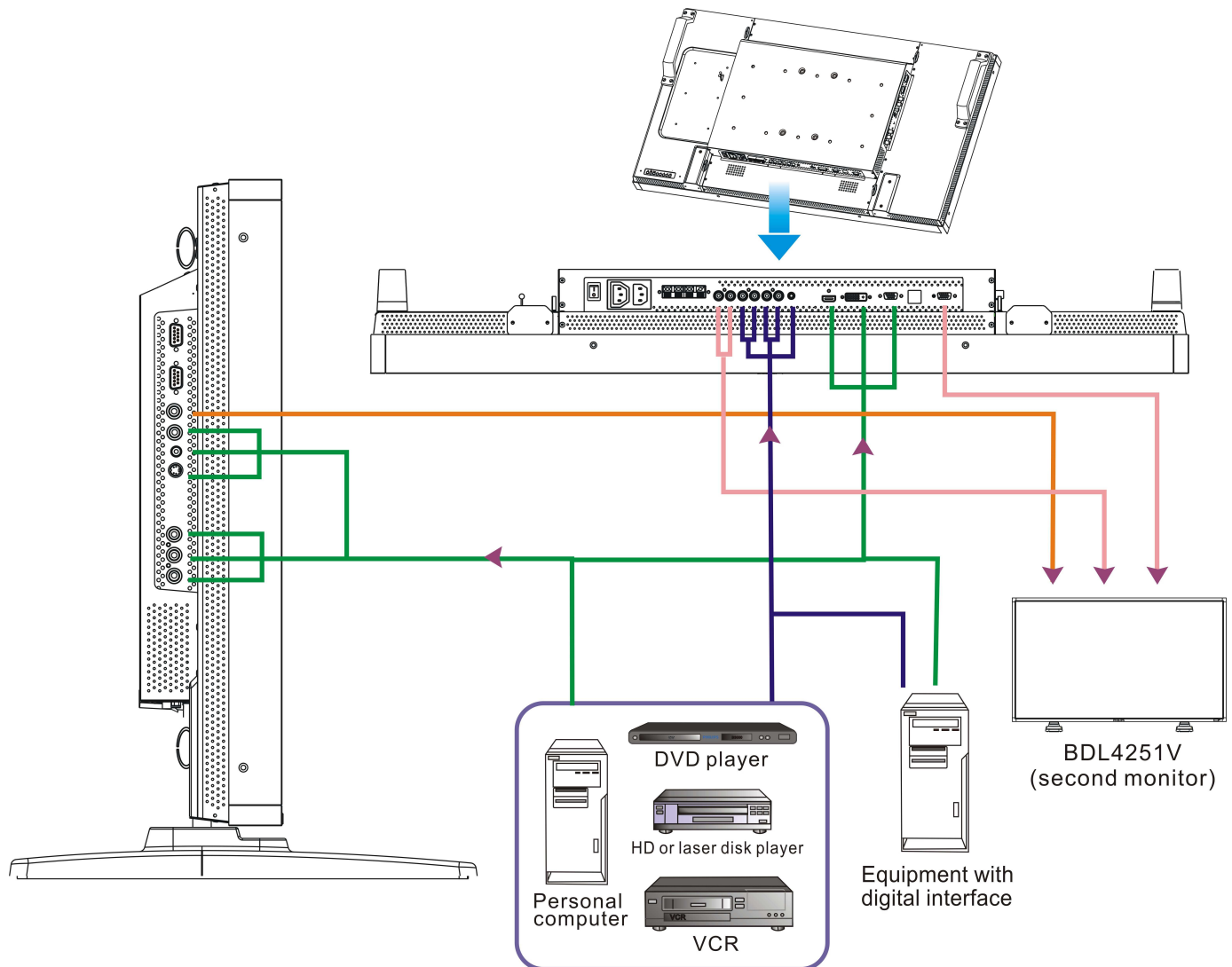

Connecting to a Personal Computer

As you finish the connection between the computer and the LCD monitor, you could play the contents in the computer and display them on the LCD monitor.

Connecting the LCD Monitor to a Personal Computer

- To achieve this, apply the supplied VGA signal cable (mini D-sub 15 pin to mini D-sub 15 pin) to make connection between a PC and the LCD monitor (VGA IN connector).
- When connecting more than one LCD monitors to a PC, apply another VGA signal cable (mini D-sub 15 pin to mini D-sub 15 pin; it's commercially available) to make connection between the LCD monitor(VGA OUT connector) and the other (VGA IN connector).
- The AUDIO IN 1, 2, 3 or HDMI can be connected for audio input. After choosing one of the AUDIO IN connectors, you might need to select AUDIO 1, 2, 3 or HDMI using the AUDIO SOURCE button on the remote control.
- When connecting more than one LCD monitors to a PC, apply RCA cable to make connection between the LCD monitor(AUDIO OUT connector) and the other (AUDIO IN 1, 2, 3). HDMI source is not suitable for this case.

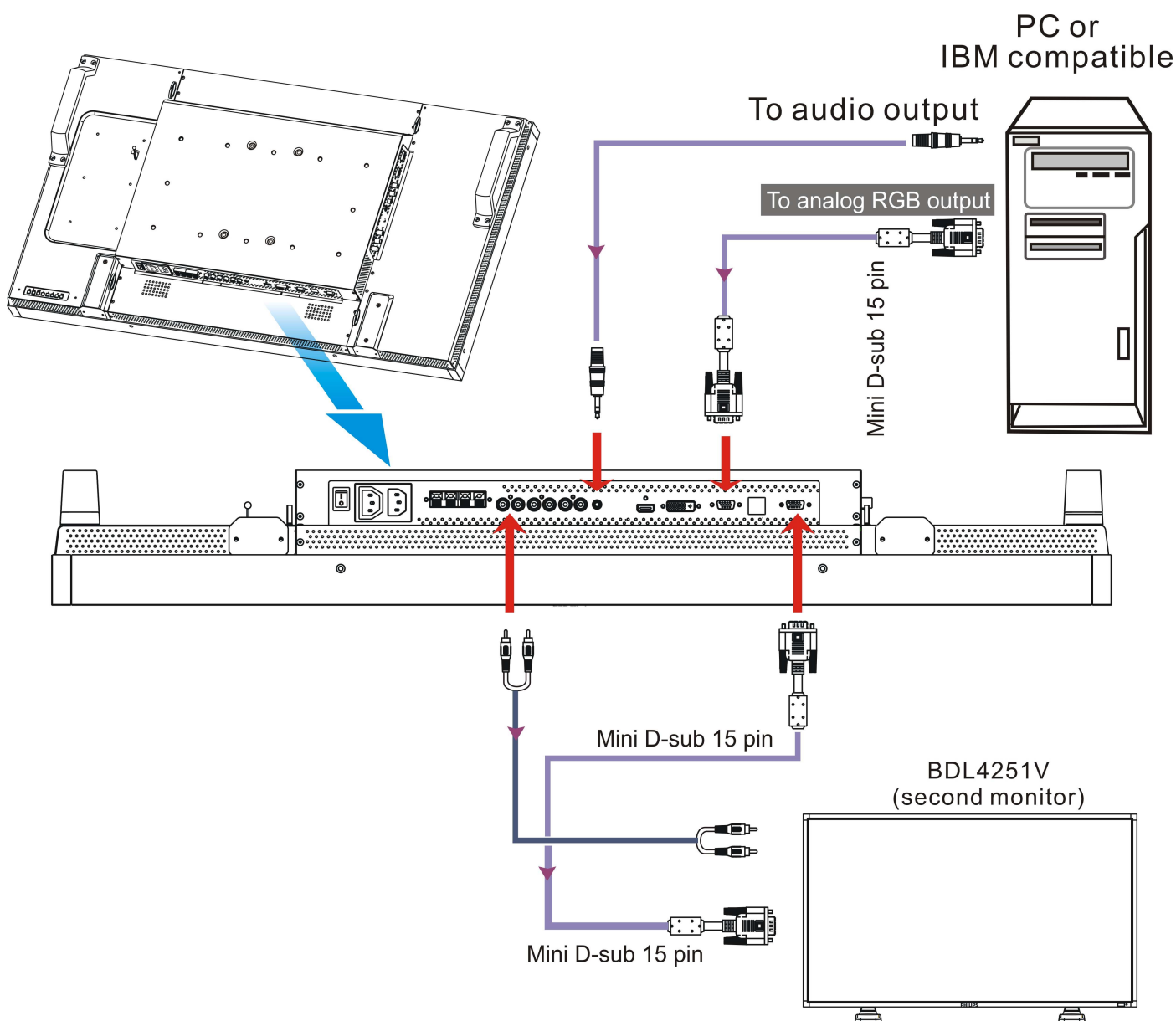

Connecting to a Digital Interface Equipment

Connections can be made between the LCD monitor and other digital equipment that is equipped with a digital interface compliant with the DVI (Digital Visual Interface) standard.

Connect the LCD Monitor to a Computer with a Digital Output

- The HDMI , DVI-D IN connector accepts a HDMI cable.
- HDMI and DVI-D can receive HDMI video signals from either a HDMI output of for instance a DVD player or from a DVI-D output of a PC.
- To ensure the display quality, use a cable with a quality prescribed by DVI standards.
- The AUDIO IN 1, 2, 3 or HDMI connector can be chosen to receive an audio source. Select AUDIO 1, 2, 3 or HDMI from the AUDIO SOURCE button on the remote control. HDMI(for audio) is only selectable only when HDMI or DVI-D (for video) is selected.
- Note that the signal of a HDMI / DVI-D connector cannot be output to the VGA OUT connector.

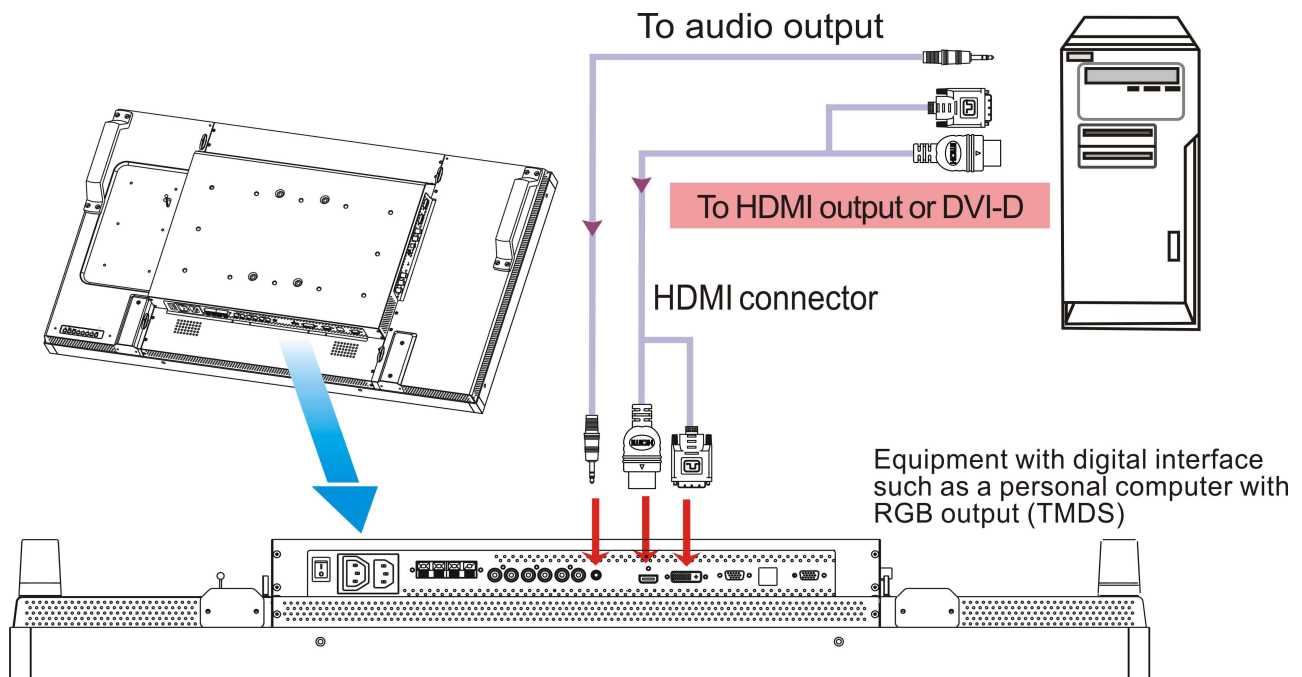

Connecting to a DVD Player

As you finish the connection between the DVD player and the LCD monitor, you could display the contents from the played DVD on the LCD monitor. You might like to refer to your DVD player's manual for further information.

Connect the LCD Monitor to a DVD Player

- To achieve this, apply a 3x components cable (Y, Pb, Pr) with BNC connectors at one end and RCA connectors at the other end between DVD player and display. In case you can only obtain RCA connectors on both ends you can use the in box available BNC-to-RCA converters. DVD player(Y, Pb, Pr Out) and LCD monitor (COMPONENT). You might need BNC-to-RCA adapters(including in the accessories) to convert the BNC connectors to RCA connectors if you are using the separated signaling(Y, Pb, Pr) RCA cable.
- If your DVD player supports HDMI signaling, apply a HDMI to HDMI cable for the connection.
- The AUDIO IN 2 , 3 (both of RCA connector type) can be used for audio input. Select [AUDIO 1] (for 3.5φ phone jack), [AUDIO 2], [AUDIO 3] Or [HDMI] from the AUDIO SOURCE button on the remote control. HDMI (for audio) is selectable only when HDMI or DVI-D (for video) is selected.

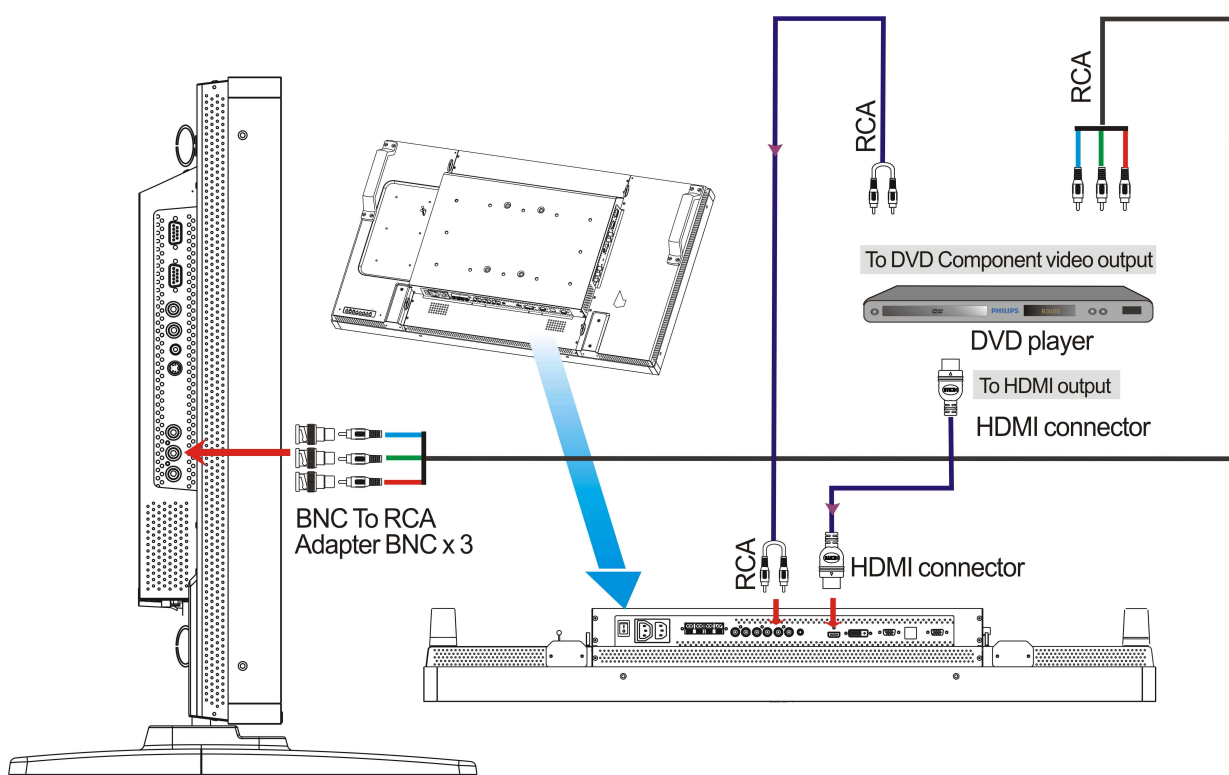

Connecting to a Stereo Amplifier

You can connect your stereo amplifier to your LCD monitor. Refer to your amplifier's manual for further information.

Connect the LCD Monitor to a Stereo Amplifier

- Turn on the LCD monitor and the amplifier only after all connections have been finished.
- Apply 2 RCA cables (audio left and right) to make connection between the amplifier (audio in) and the LCD monitor (audio out).
- Do not reverse the audio left and right jacks.
- For the preferred audio signal, select [AUDIO1], [AUDIO2], [AUDIO3] or [HDMI] from the AUDIO SOURCE button on the remote control. HDMI(for audio) is selectable only when HDMI or DVI-D (for video) is selected.
- The AUDIO OUT RCA connectors output sound from the selected AUDIO SOURCE.

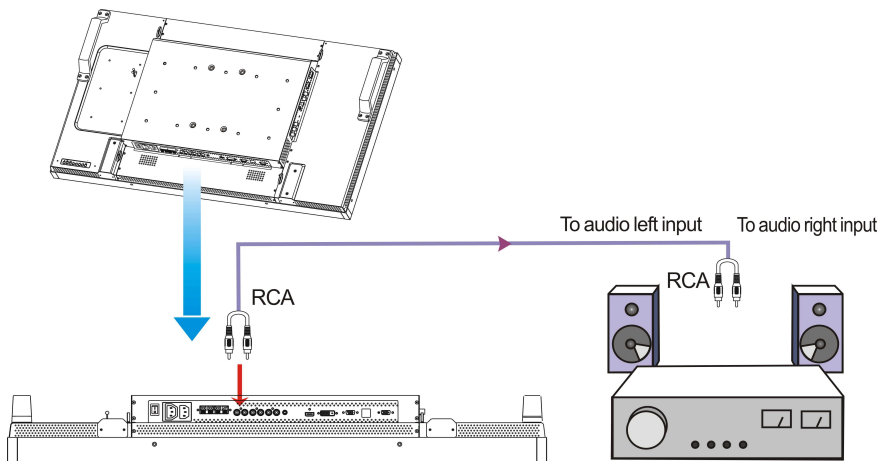

Connecting to a display mounted PC

This monitor has an area in the backcover to mount a small form fact PC or set-top box. You can connect your mounted PC to your LCD monitor. Use M4 mounting screws for 100x234 mm to fix your mount PC.

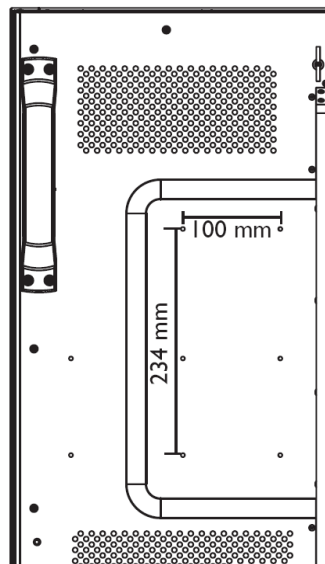

Basic Operation

Power ON and OFF Modes

The LCD monitor power indicator will turn green while powered on and will turn red while powered off. The monitor can be powered on or off using the following three options:

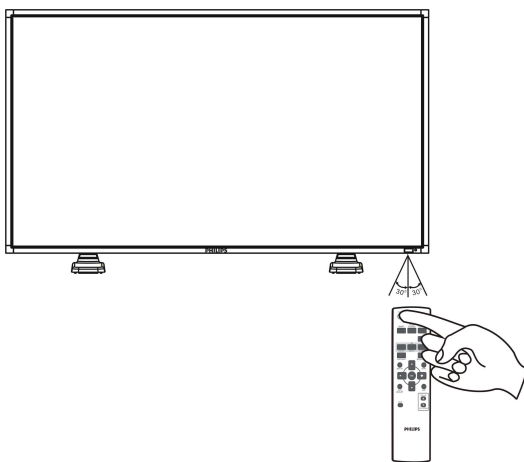
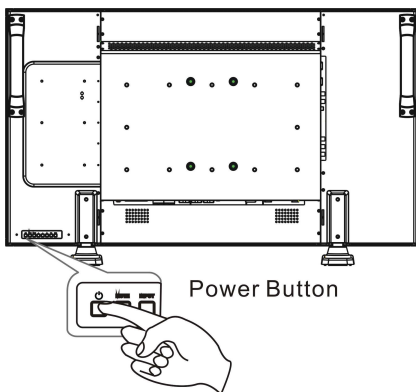
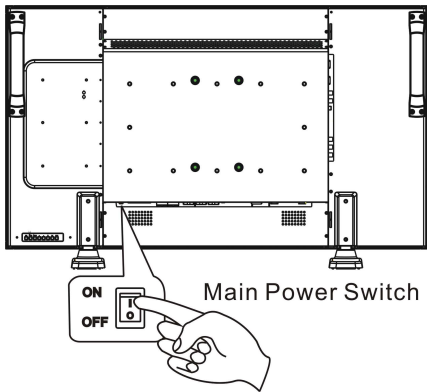

1. Pressing the Main Power Switch.

NOTE:

When the Main Power Switch is used to power off the LCD monitor, the remote control, the power button and the indicator will not work. Make sure to turn the Main Power Switch on before using the other two options.

2. Pressing the power button.

NOTE:

Before pressing the power button, be sure to turn on the Main Power button on the LCD monitor.

3. Using the remote control.

NOTE:

Before operating the remote control, be sure to turn on the Main Power Switch on the LCD monitor.

Power Indicator

	Status
Power ON	Green
Power Standby	Red
Power OFF	LED Off
Diagnosis (Detecting failure)	Red Blinking * See troubleshooting

Using Power Management

Please turn off the LCD monitor when it will not be used for long time. This could potentially increase the life and decrease the power consumption of the LCD monitor.

Standby mode: Push the power button on the remote control or on the monitor to enter the standby mode.

Power Off: Push the Main Power Switch to enter the power off mode.

Display Signal of Video Source Setting to [VIDEO]

Use the input button on the front panel or the VIDEO SOURCE button on the remote control to set video source to [VIDEO].

Use the COLOR SYSTEM OSD menu to select [AUTO], [NTSC], [PAL], [SECAM], [PAL60], [4.43NTSC], according to your video format.

Picture Size

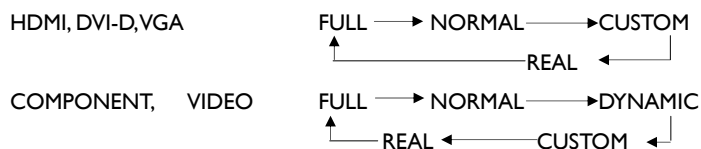

Signal Type	NORMAL SIZE	Recommended Size
4:3		NORMAL
		DYNAMIC
Squeeze		FULL

NORMAL: Display with the input signal aspect ratio from PC signal, or display in 4:3 aspect ratio at COMPONENT or VIDEO signal.

FULL: Display in the entire screen.

DYNAMIC: Expand 4:3 pictures to the entire screen with non-linearity. (Some round image might be cut by expansion.)

CUSTOM (ZOOM): Images can be expanded beyond the active display area. The image which is outside of the active display area would not be shown.

REAL: Image will be displayed for one by one pixel.

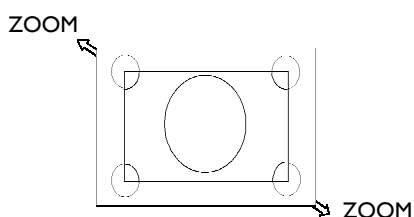

Smart Picture Mode

HDMI ,VGA



COMPONENT,VIDEO



Audio Source Switching

You can select the audio source using the AUDIO SOURCE button on the remote control.

HDMI

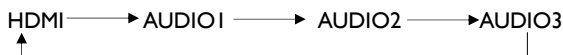

Control Lock Mode

This function disables the operation of buttons so that the adjustments you make are not active when they are pressed.

To disable the buttons, press and hold down the ▲ and ▼ buttons together for at least 3 seconds.

To enable the buttons, press and hold down the ▲ and ▼ buttons together for at least 3 seconds again.

OSD Information

HDMI , VGA

VGA
1024 x 768
48kHz 60Hz
AUDIO : 1
SIZE : FULL

- ← Video Source
- ← Input signal Information
- ← Audio Source
- ← Picture Size

COMPONENT

COMPONENT
AUDIO : 3
SIZE : FULL

- ← Video Source
- ← Audio Source
- ← Picture Size

S-VIDEO, VIDEO

S-VIDEO
NTSC
AUDIO : 3
SIZE : NORMAL

- ← Video Source
- ← Color System of Input Signal
- ← Audio Source
- ← Picture Size

PIP or POP

Main:VGA

Sub:S-VIDEO

VGA
1024 x 768
48kHz 60Hz
AUDIO : 1
S-VIDEO
NTSC
SIZE : FULL

- ← Main picture Information
- ← Sub picture Information
- ← Main picture Information

OSD (On-Screen-Display) Controls

Press MENU button to open Main menu. Press UP or DOWN button to select sub-menu.

Press SET button to enable setting.

Press UP or DOWN, and PLUS or MINUS button to select function, or adjust the setting. Press SET button to enable the setting.

Press MENU or EXIT button to exit.

Remote Control

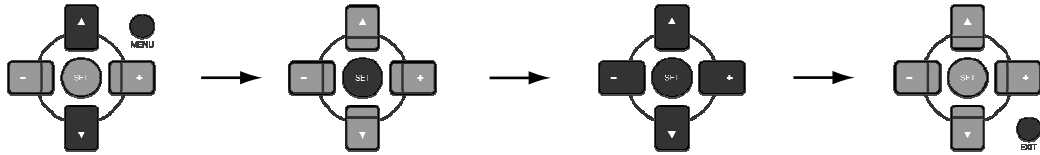

Press EXIT button to open Main menu. Press UP or DOWN button to select.

Press INPUT button to enable the setting.

Press UP or DOWN, and PLUS or MINUS button to select function, or adjust the setting. Press INPUT button to enable the setting.

Press EXIT button to exit.

Control Panel

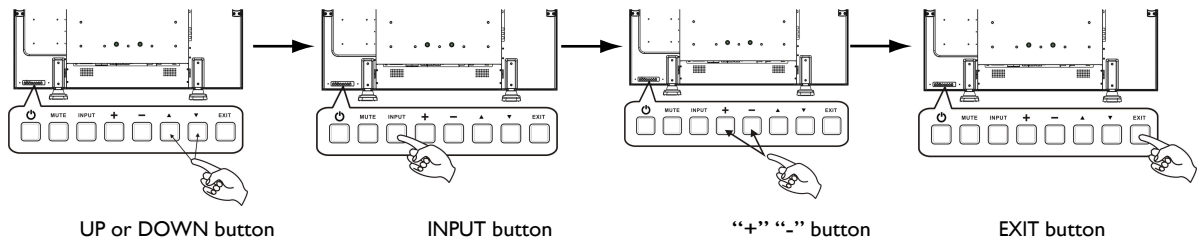

OSD screen

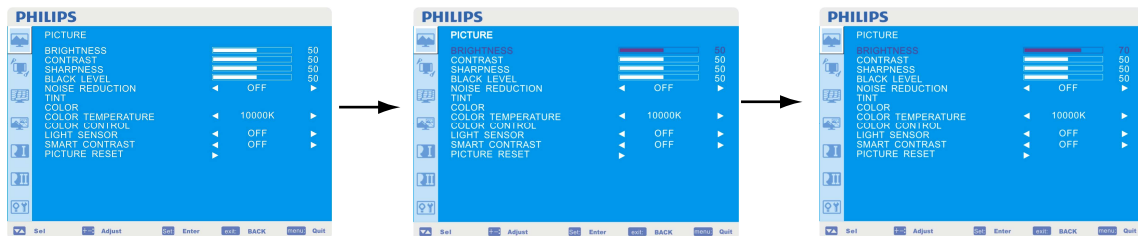

Main-Menu

PICTURE

■ BRIGHTNESS

Adjusts the overall image and background screen brightness.
 Press + button to increase brightness.
 Press - button to decrease brightness.

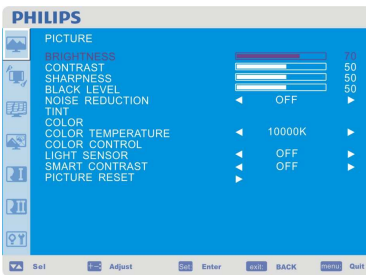

■ CONTRAST

Adjusts the image brightness for the input signal.
 Press + button to increase contrast.
 Press - button to decrease contrast.

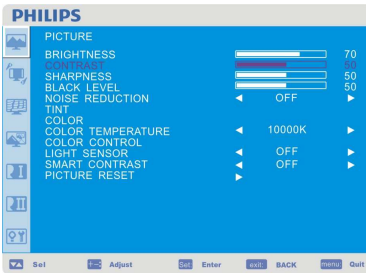

■ SHARPNESS

This function is digitally capable to keep crisp images at any timing.
 It is adjustable to get a distinct image or a soft one as you prefer and set independently for each picture mode.
 Press + button to increase sharpness.
 Press - button to decrease sharpness.

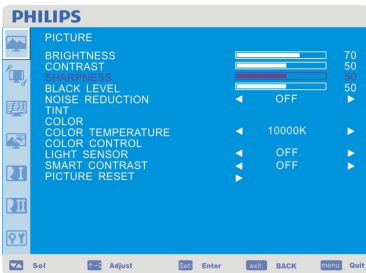

■ BLACK LEVEL

Adjusts the image brightness for the background.
 Press + button to increase black level.
 Press - button to decrease black level.
 NOTE: sRGB picture mode is standard and cannot be changed.

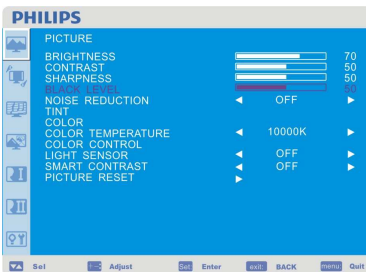

■ NOISE REDUCTION

Adjusts the noise reduction level.
 Press + button to increase reduction level.
 Press - button to decrease reduction level.

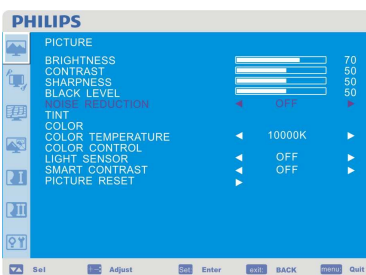

■ TINT * : INPUT HDMI , (HDMI INPUT MODE-HD), COMPONENT, S-VIDEO, VIDEO only

Adjusts the tint of the screen.
 Press + button the flesh tone color becomes greenish.
 Press - button the flesh tone color becomes purplish.



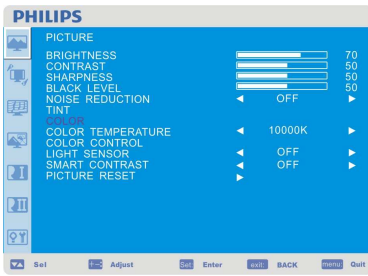

■ **COLOR** *: INPUT HDMI , DVI-D(INPUT MODE-HD), COMPONENT, S-VIDEO, VIDEO only

Adjusts the color of the screen.
Press + button to increase color depth.
Press - button to decrease color depth.



■ **COLOR TEMPERATURE**

Is used to adjust the color temperature.
The image becomes reddish as the color temperature decreases, and becomes bluish as the color temperature increases.



■ **COLOR CONTROL**

The color levels of red, green, and blue are adjusted by the color bars.
R: Red, G: Green, B: Blue



■ **LIGHT SENSOR**

Select "ON" to enable the ambient light sensor. The image brightness will be auto adjusted when ambient light changed.

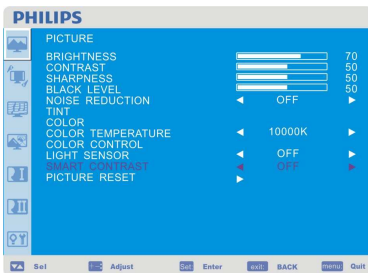

■ **SMART CONTRAST**

Select "ON" to enable the smart contrast. Can enhancement the image of high contrast ratio.

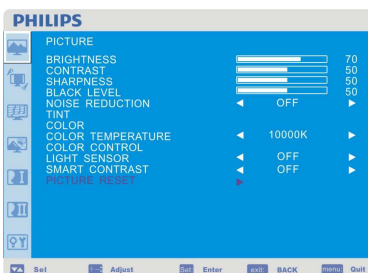

■ **PICTURE RESET**

Selecting Picture reset allows you to reset all OSD settings about PICTURE setting.
Select "Yes" and press "SET" button to restore to factory preset data.
Press "EXIT" button to cancel and then return to the previous menu.

Main-Menu

SCREEN

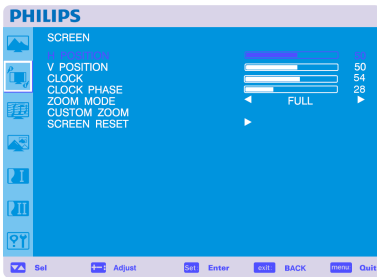

■ H POSITION

Controls Horizontal Image position within the display area of the LCD.
 Press + button to move screen to right.
 Press - button to move screen to left.

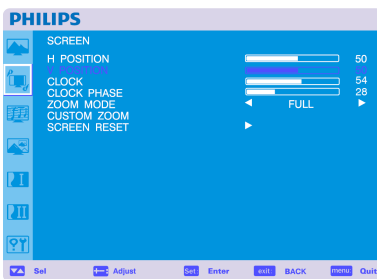

■ V POSITION

Controls Vertical Image position within the display area of the LCD.
 Press + button to move screen to UP.
 Press - button to move screen to DOWN.

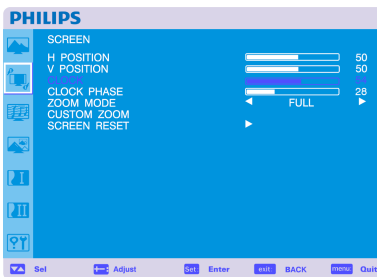

■ CLOCK * : INPUT VGA only

Press + button to expand the width of the image on the screen the right.
 Press - button to narrow the width of the image on the screen the left.

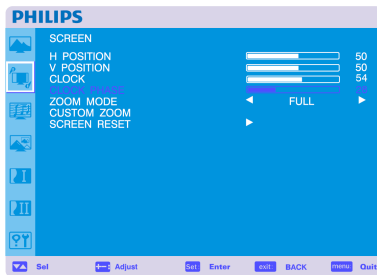

■ CLOCK PHASE * : INPUT VGA only

Improves focus, clarity and image stability by increasing or decreasing this setting.

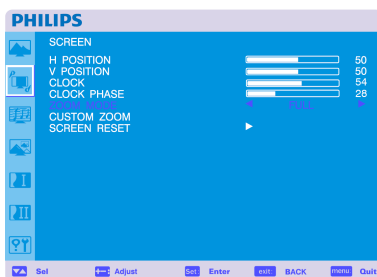

■ ZOOM MODE

You can select "FULL", "NORMAL" and "CUSTOM" and "REAL". (INPUT HDMI,DVI-D,VGA only)
 You can also select "FULL", "NORMAL" "DYNAMIC" and "CUSTOM" and "REAL". (INPUT COMPONENT, S-VIDEO, VIDEO only)
 Selecting "DYNAMIC" will make the screen display panoramic with the expansion of the middle and outside of the screen changed. (The upper and the bottom of the image will be cut by expansion.)
 Dynamic image is the same as FULL size image when HDTV signal is input.
 Selecting "REAL" image will be displayed 1 by 1 pixel.

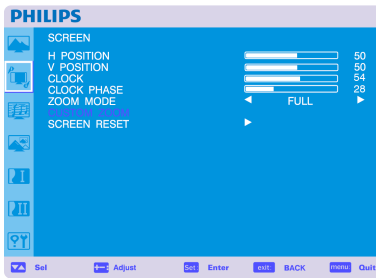

■ CUSTOM ZOOM

“CUSTOM ZOOM” will be selected when you select “CUSTOM” on the screen “ZOOM” mode.

ZOOM: expands the horizontal and the vertical size simultaneously.

HZOOM: expands the horizontal size only.

VZOOM: expands the vertical size only.

H POSITION: moves to the right with + button. moves to the left with – button.

V POSITION: moves up with + button. moves down with – button.

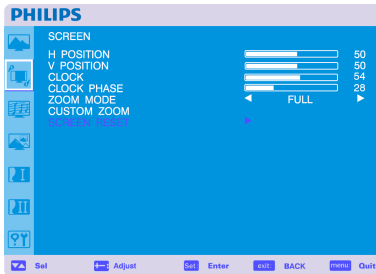

■ SCREEN RESET

Selecting Screen reset allows you to reset all OSD settings from PICTURE setting.

Select “Yes” and press “SET” button to restore the factory preset data.

Press “EXIT” button to cancel and then return to the previous menu.

Main-Menu

AUDIO

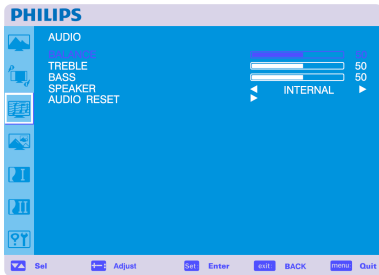

■ BALANCE

Adjusts the balance of L/R volume.
 Press + button to move the stereo sound image to right.
 Sound of the left side will be small.
 Press - button to move the stereo sound image to left.

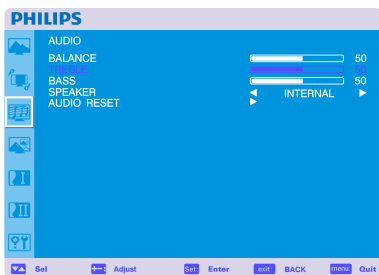

■ TREBLE

This feature helps you to accentuate or reduce the high frequency sound.
 Press + button to increase TREBLE sound.
 Press - button to decrease TREBLE sound.

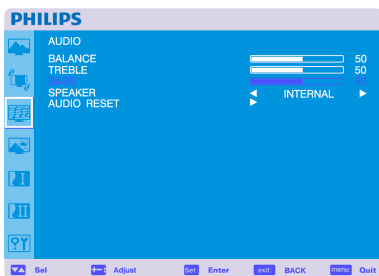

■ BASS

This feature helps you to accentuate or reduce the low frequency sound.
 Press + button to increase BASS sound.
 Press - button to decrease BASS sound.

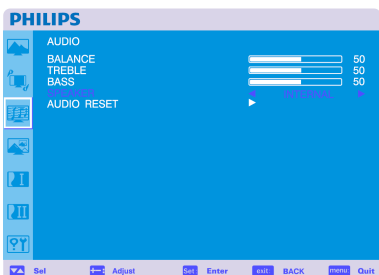

■ SPEAKER

This feature helps you to cut the internal or the external loudspeaker.
 Press + or - button to exchanges the internal and the external loudspeaker.

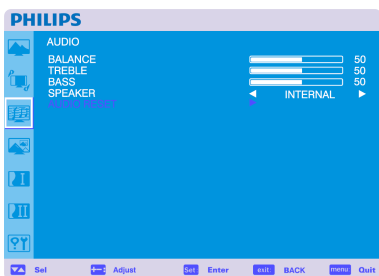

■ AUDIO RESET

Selecting Audio reset allows you to reset all OSD settings from AUDIO setting.
 Select "YES" and press "SET" button to restore the factory preset.
 Press "EXIT" button to cancel and then return to the previous menu.

Main-Menu

PIP (PICTURE IN PICTURE)

Note: The "PIP" and "POP" modes do not function when the screen size is "CUSTOM" or "REAL".



■ PIP SIZE

Selecting the size of picture inserted at the "Picture-in-Picture" (PIP) mode. "Large", "Middle" and "Small" are available.

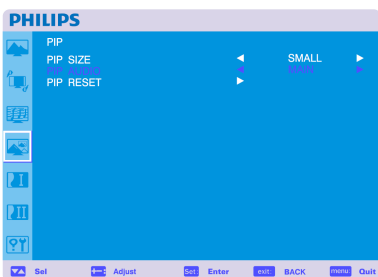

■ PIP AUDIO

Selecting the sound source in PIP mode.

When selecting "MAIN AUDIO", you will get the sound for the main picture and when selecting "PIP AUDIO", you will get the sound for the picture instead.

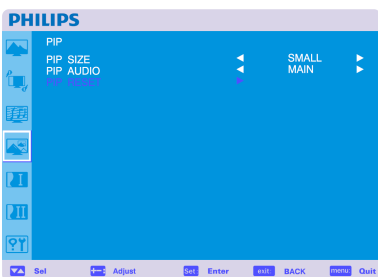

■ PIP RESET

Selecting PIP Reset allows you to reset all OSD settings from PIP setting. Select "Yes" and press "SET" button to restore the factory preset data. Press "EXIT" button to cancel and then return to the previous menu.

Main-Menu

CONFIGURATION I



■ AUTO ADJUST * : INPUT VGA only

Press "SET" button to automatically adjust screen size, horizontal position, vertical position, clock, clock phase, white level and black level.

Press "EXIT" button to cancel execution AUTO ADJUST and then will return to the previous menu.



■ POWER SAVE

Selecting RGB "ON", the monitor will go to power management mode when HDMI, DVI-D,VGA, sync is lost.

Selecting VIDEO "ON", the monitor will go to power management mode after about 10 minutes delay from when COMPONENT and VIDEO input signal is lost.

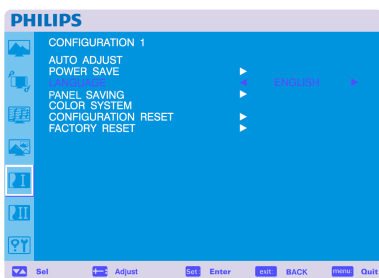

■ LANGUAGE

OSD control menus are available in eight languages.

(English, German, French, Italian, Spanish, Polish, Turkish, Russian, Simple Chinese)

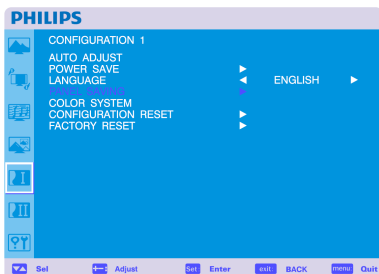

■ PANEL SAVING

Select "PANEL SAVING" functions to reduce the risk of the "image persistence".

COOLING FAN: The cooling fan will be auto-turned on and off according to temperature of monitor when selected "AUTO". The cooling fan will be turned on always when selected "ON".

BRIGHTNESS: The brightness is decreased when selected "ON".

PIXEL SHIFT: Image is slightly expanded and moves 4 directions (UP, DOWN, RIGHT, LEFT) periodically (Need setting the time for movement).

Movement area is approximately +/- 10mm from original position;

Please locate the important information such as text within 90% area of screen image.

See note (I) for this functions.

PIP and STILL will be disabled when "MOTION" is active.



■ COLOR SYSTEM * : INPUT S-VIDEO, AV only

Selecting the Color System depends on your input video format.

AUTO: NTSC, PAL, SECAM, PAL60 or 4.43 NTSC is automatically selected.

NTSC: Specific selection of NTSC.

PAL: Specific selection of PAL.

SECAM: Specific selection of SECAM.

PAL-60: Specific selection of PAL60.

4.43NTSC: Specific selection of 4.43 NTSC.

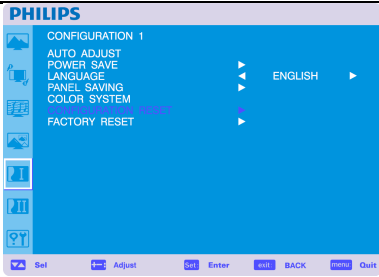

■ CONFIGURATION RESET

Selecting the CONFIGURATION RESET allows you to reset all configuration settings. Select "Yes" and press "SET" button to restore the factory preset data. Press "EXIT" button to cancel and return the previous menu.

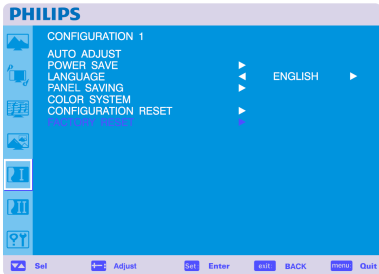

■ FACTORY RESET

Selecting "YES" allows you to reset PICTURE, SCREEN, AUDIO, CONFIGURATION 1,2 and ADVANCED OPTION will be back to factory settings (except LANGUAGE, DATE AND TIME and SCHEDULE).

Select "YES" and press "SET" button to restore the factory preset data. Press "EXIT" button to cancel and return the previous menu.

Main-Menu

CONFIGURATION 2

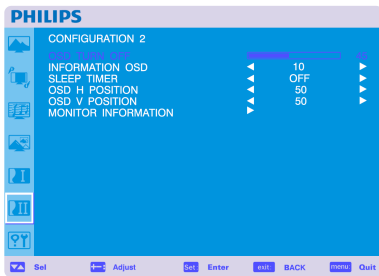

OSD TURN OFF

The OSD control menu will stay on as long as it is used. In the OSD Turn Off submenu, you can select how long the monitor waits after the last touch of a button to shut off the OSD control menu. The preset choices are 5 - 120 seconds.

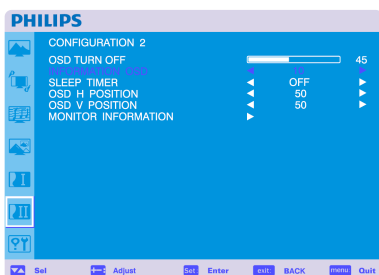

INFORMATION OSD

Selects the information OSD to be displayed or not. The information OSD will be displayed when the input signal is changed or a source change or warning message like no-signal or out-of range. A time between 1 to 10 seconds is available.

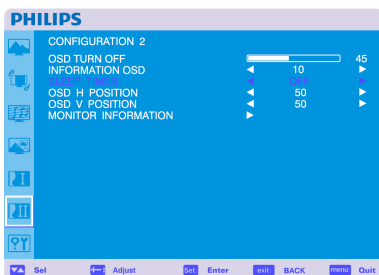

SLEEP TIMER

To select SLEEP TIMER mode ON/OFF. In the SLEEP TIMER menu, you can preset the monitor to automatically power down. A time between 1 to 24 hours is available. When the SLEEP TIMER is set, the SCHEDULE settings will be disabled.

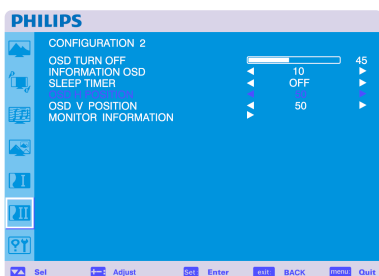

OSD H POSITION

Adjusts the horizontal position of the OSD menu.

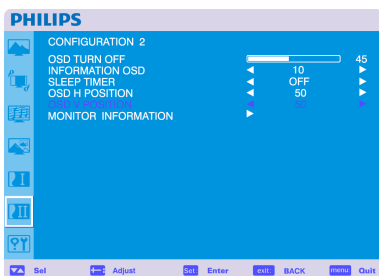

OSD V POSITION

Adjusts the vertical position of the OSD menu.

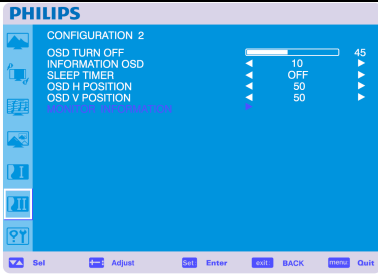

MONITOR INFORMATION

Indicates the model and serial number of your monitor.

Main-Menu

ADVANCED OPTION

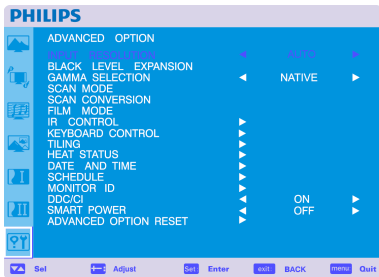

■ INPUT RESOLUTION * : INPUT VGA only

This feature makes the display controlling the source in order to match display capabilities by choice or automatically. You can select one of the following timings:

- (1) 1024x768, 1280x768, 1360x768 and 1366x768.
- (2) 640x480, 720x480 and 852x480
- (3) 800x600, 1064x600 and 720x576
- (4) 1400x1050 and 1864x1050
- (5) 720x400 and 640x400

AUTO: Determines the resolution automatically.

The setting you select becomes effective when POWER is turned OFF and ON again.

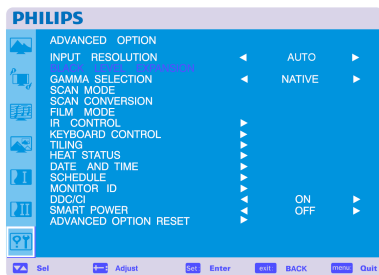

■ BLACK LEVEL EXPANSION * : INPUT HDMI, DVI-D(MODE-HD), S-VIDEO, VIDEO only

Selects a level of black expansion from "OFF", "LOW", "MIDDLE" and "HIGH".

In case of go under the black cut-off level, please adjust the "Black level" in moderation on OSD menu.

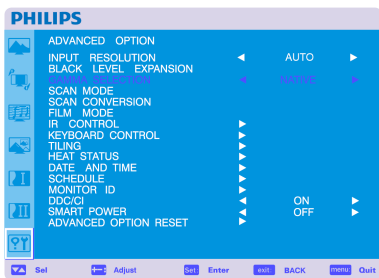

■ GAMMA SELECTION

Selects a display gamma. It refers to the brightness performance curve of signal input.

- 2.2
- 2.4
- S gamma
- Native

NOTE: sRGB picture mode is standard and cannot be changed.

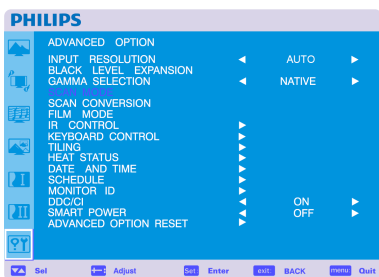

■ SCAN MODE * : INPUT HDMI, DVI-D(MODE-HD), S-VIDEO, VIDEO only

Changes the display area of the image.

OVERSCAN: Set to display area about 95%

UNDERSCAN: Set to display area about 100%

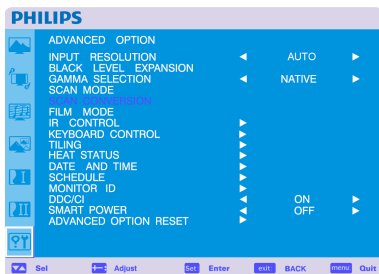

■ SCAN CONVERSION * : INPUT HDMI, DVI-D(MODE-HD), S-VIDEO, VIDEO only

Selects IP (Interlace to Progressive) converter function.

PROGRESSIVE: Enable the IP function, to convert interlace signal to progressive. Normally use this setting.

INTERLACE*: Disable the IP function.

*NOTE: This mode is better suited for motion pictures, but it increases chance of image retention.

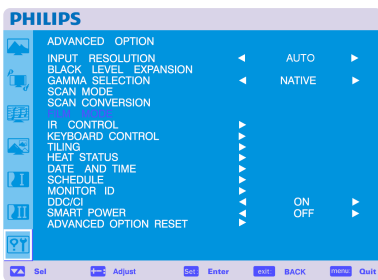

■ FILM MODE * : INPUT HDMI, DVI-D(MODE-HD), S-VIDEO, VIDEO only

Selects Film mode function.

AUTO: Enable the Film mode function. This mode is better suited for movies, which is converted 24 Frames/sec source to DVD Video. We recommend to select "PROGRESSIVE" in "SCAN CONVERSION".

OFF: Disable the Film mode function. This mode is better suited for Broadcasting or VCR source.

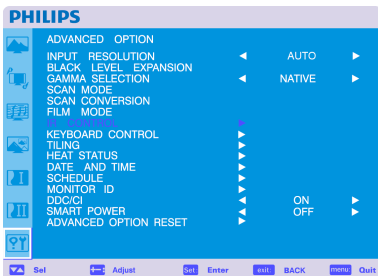

■ IR CONTROL

Selects the operation mode of the remote controller when multiple BDL4251V monitors are connected via RS232C.

The item in this menu will become effective by pressing "SET" button on the selected item.

NORMAL: The monitor will be controlled normally by remote controller.

PRIMARY: The first BDL4251V monitor of those multi-connected via RS232C is designated as PRIMARY.
SECONDARY: BDL4251V monitors other than the first one multi-connected via RS232C are designated as SECONDARY.

LOCK: Disable the monitor control by infrared remote controller.

Keep pressing "DISPLAY" button during 5 sec or more, this setting will return to "NORMAL".

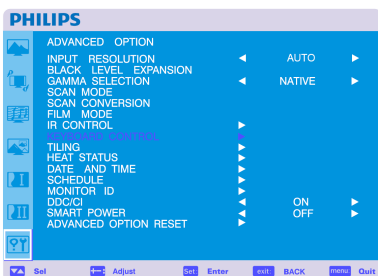

■ KEYBOARD CONTROL

Selects the operation mode of the keyboard control.

Select "LOCK" to disable the keyboard.

Select "UNLOCK" to enable the keyboard.

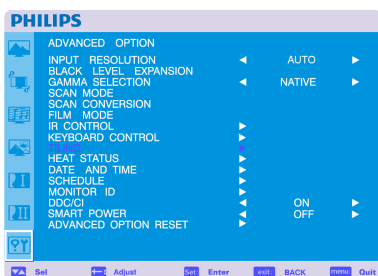

■ TILING

TILING demonstrates multiple screens. This feature provides a single large screen using up to 25 monitors. It will be able to divide up to 5 each H and V.

This requires you to feed the PC output into each of the monitors through a distributor.

H MONITORS: Select number of horizontal monitors.

V MONITORS: Select number of vertical monitors.

POSITION: Select a position to expand the screen.

FRAME COMP: Works in tandem with TILING to compensate for the width of the tile bezels in order to accurately display the image.

ENABLE: Select "YES", the monitor will expand the selected position.

PIP and STILL will be disabled when "TILING" is activated.

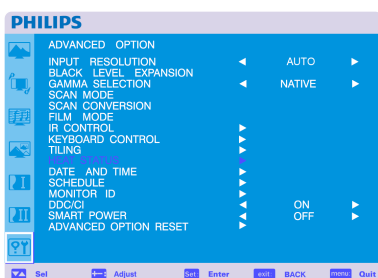

■ HEAT STATUS * :Disclaimer: Heat sensor is indicative.

HEAT STATUS allows you to watch the thermal status at any time via the OSD menu and/or via RS232C commands. The indicated temperature has a accuracy of 3 degrees (plus and minus)..

Press "SET" button to enter the submenu to monitor the heat status.

Press "EXIT" button to cancel and then return the previous menu.

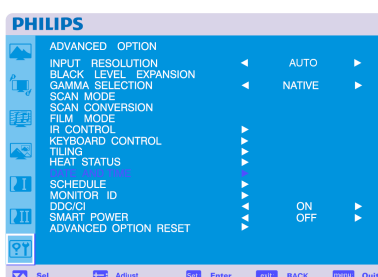

■ DATE AND TIME

Adjusts the current date and time for internal clock.

You should set this function when you use "SCHEDULE".

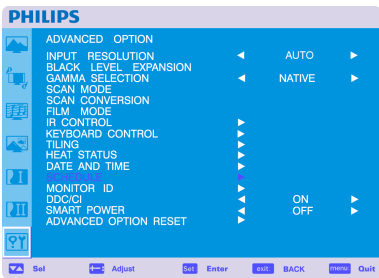

SCHEDULE

Programs the monitor's working schedule. Schedules the power on and power off by using hour and a day of the week. Also sets the input port. This OSD can't be removed except EXIT.

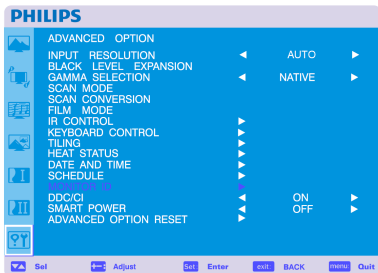

MONITOR ID

ID numbers for remote control are assigned to BDL4251V monitors that are multi-connected via RS232C. ID numbers 1 to 26 are selectable.

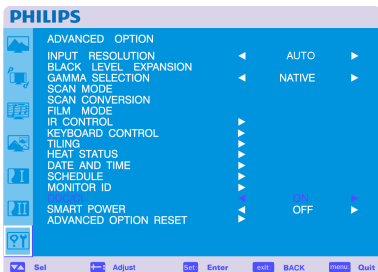

DDC/CI

Use to turn ON or OFF the DDC/CI communication function. Select ON for normal use.

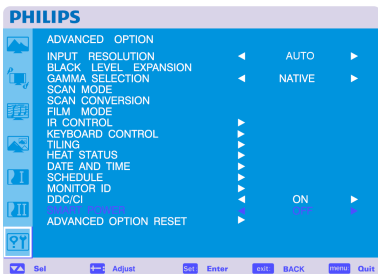

SMART POWER

Selecting SMART POWER allows you to choose a certain level of power saving condition. Select "OFF" to set the system in normal power condition. Select "MEDIUM" to set the system in medium level power saving status. Select "HIGH" to set the system in high level power saving status. Press "EXIT" button to cancel and then return the previous menu.

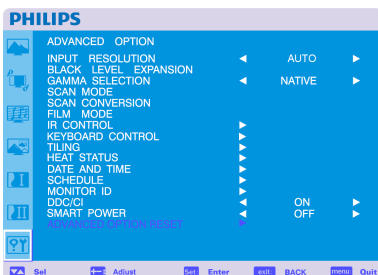

ADVANCED OPTION RESET

Selecting ADVANCED OPTION RESET allows you to reset all OSD settings from ADVANCED OPTION settings, except for GAMMA SELECTION, DATE AND TIME, SCHEDULE, HDMI INPUT MODE, DVI-D INPUT MODE, MONITOR ID, and DDC/CI. Select "YES" and press "SET" button to restore the factory preset data. Press "EXIT" button to cancel and then return the previous menu. GAMMA SELECTION is reset when carrying out the PICTURE RESET in the PICTURE.

NOTE

NOTE 1: IMAGE PERSISTENCE

Please be aware that LCD Technology may experience a phenomena known as Image Persistence. Image Persistence occurs when residual or “ghost” image of a previous image remains visible on the screen. Unlike CRT monitors, LCD monitors’ image persistence is not permanent, but constant images being displayed for a long period of time should be avoided. To alleviate image persistence, turn off the monitor for as long as the previous image was displayed. For example, if an image was on the monitor for one hour and a residual image remains, the monitor should be turned off for one hour to erase the image. As with all personal display devices, PHILIPS recommends displaying moving images and using a moving panel saving at regular intervals whenever the screen is idle or turning off the monitor when not in use.

Please set “POWER SAVE”, “PANEL SAVING”, “DATE AND TIME” and “SCHEDULE” functions to further reduce the risk of Image persistence.

For long life use of Public Display

< Image Sticking of LCD Panel >

When LCD panel is operated continuously for long hours, a trace of electric charge remains near the electrode inside LCD, and residual or “ghost” image of previous image may be observed. (Image Persistence)

Image Persistence is not permanent, but when fixed image is displayed for long period, ionic impurities inside LCD are accumulated along the displayed image, and it is observed permanently. (Image Sticking)

< Recommendations >

For preventing the fast transition to Image Sticking, and for longer life usage of LCD, following are recommended.

1. Static images should not be displayed for long period. Always use a short cycle to change to other images.
2. In case a fixed image is displayed for a long period, it is advised to activate the pixel shift feature that will periodically move the image in four directions
3. When not in use, please turn off the monitor with your remote control, or use Power Management Function or use the Schedule Function of monitor.
4. Reducing the environmental temperature will increase the life of your monitor.
When Protection board (glass, acryl) is installed over the LCD surface, enclosed into the box / wall, or stack the monitor, please utilize the temperature sensors inside monitor.
To reduce the environmental temperature, the monitor should be set Low Brightness or Cooling Fan “ON” by using Screen sever Function.
5. Please use "Panel saving Mode" of monitor.

NOTE 2: HOW TO SETUP SCHEDULE

Using the “SCHEDULE” function allows you to set up to seven different scheduled time intervals when the LCD Monitor will be activated. You can select the time the monitor turns on and turns off, the day of week the monitor is activated, and which input source the monitor will use for each scheduled activation period. A check mark in the box next to the number of the schedule indicates that the selected schedule is in effect.

To select which schedule to set, use the up/down arrows to move the number (1 to 7) of the schedule.

Use the (+) and (-) buttons to move the cursor horizontally within the particular schedule. Use the (▲) and (▼) buttons to increase time and select input port. The “SET” button is used to make a selection.

If you create a schedule but do not want to use a power on time, select “--” in the “ON” time slot.

If you do not want to use a power off time select “--” in the OFF time slot.

If there is no input selected (“--” showing in the input spot) the input from the previous schedule will be used.

The selection of EVERY DAY within a schedule takes priority over other schedules that are set up to operate weekly. When schedules are overlapping, scheduled Power ON time has priority over scheduled Power OFF time.

If there are two schedules programmed for the same time, then the highest numbered schedule has priority. When the “SLEEP TIMER” is set, the “SCHEDULE” function is disabled.

NOTE 3: “PIP”, “POP” and “SIDE BY SIDE”

The following table shows the combination of signal inputs under which the “PIP” and “POP” modes function. These modes do not function, however, when the screen size is “CUSTOM” or “REAL”.

		SUB					
		HDMI	DVI-D	VGA	COMPONENT	S-VIDEO	VIDEO
MAIN	HDMI	x	x	x	x	○	○
	DVI-D	x	x	x	x	○	○
	VGA	x	x	x	x	○	○
	COMPONENT	x	x	x	x	○	○
	S-VIDEO	○	○	○	○	x	x
	VIDEO	○	○	○	○	x	x

○: Supported
x: Not supported

Press the “PIP ON/OFF” buttons on the remote control to change between “PIP”, “POP” and “SIDE BY SIDE” mode as shown in the diagram below.

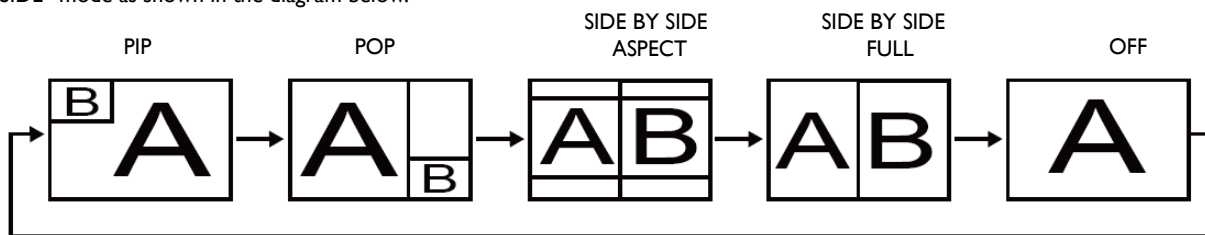

“PIP”, “POP” mode resolution (Reference)

- PIP SIZE < SMALL > : 450 dots X 338 dots
- < MIDDLE > : 675 dots X 450 dots
- < LARGE > : 900 dots X 675 dots
- POP SIZE : 450 dots X 338 dots

< Remote control numbering function >

By connecting multiple BDL4251V monitors using RS232C cables, you can control any one monitor or all the monitors by one remote controller.

- Assign arbitrary ID number to each of multi-connected BDL4251V monitors using MONITOR ID. ID numbers 1 to 26 are selectable.
It is recommended to assign sequential ID numbers from 1 and up.
- The remote control mode of the first BDL4251V monitor is set to PRIMARY and those of the other monitors are set to SECONDARY.
- When you direct the remote controller at the remote control signal sensor of the PRIMARY monitor and press the DISPLAY button on the remote controller, the ID selection OSD appears at the upper left of the screen.

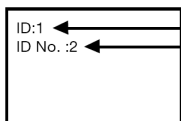

ID number of the currently viewed monitor

Select the ID number of the monitor you want to control using the +/- button on the remote controller.
The ID of the monitor you want to control is displayed at the upper left of its screen.
By selecting ALL, you can control all the multi-connected monitors.

- Direct the remote controller at the remote control signal sensor of the PRIMARY monitor. OSD appears on the monitor having the ID number you selected.

NOTE:

When the ID selection OSD is being displayed on the PRIMARY monitor, press the DISPLAY button on the remote controller again to cancel the ID selection OSD and then control the monitor you selected.

HINT:

If you set the remote control mode wrongly and remote control operation becomes unavailable, press MENU button on the control panel of the monitor to display the OSD screen and change the remote control mode using ADVANCED OPTION. By pressing and holding down the DISPLAY button on the remote control for 5 seconds or longer, the remote control mode is initialized to NORMAL.

Pixel defect policy BDL4251V

Philips strives to deliver the highest quality products. We use some of the industry's most advanced manufacturing processes and practice stringent quality control. However, pixel or sub-pixel defects on the PDP / TFT panels used in Plasma- & LCD- displays are sometimes unavoidable. No manufacturer can guarantee that all panels will be free from pixel defects, but Philips guarantees that any Plasma- & LCD- displays with an unacceptable number of defects will be repaired during the warranty period in line with your local guarantee conditions.

This notice explains the different types of pixel defects and defines the acceptable defect level for the BDL4251V LCD screen. In order to qualify for repair under warranty, the number of pixel defects must exceed a certain level which is given in the reference table. If the LCD screen is within specification a warranty exchange / claim back will be refused. Additionally, because some types or combinations of pixel defects are more noticeable than others, Philips sets even higher quality standards for those.

Pixels and Sub-pixels

A pixel, or picture element, is composed of three sub-pixels in the primary colors of red, green and blue. Many pixels together form an image. When all sub-pixels of a pixel are lit, the three colored sub-pixels together appear as a single white pixel. When all are dark, the three colored sub-pixels together appear as a single black pixel. Other combinations of lit and dark sub-pixels appear as single pixels of other colors.

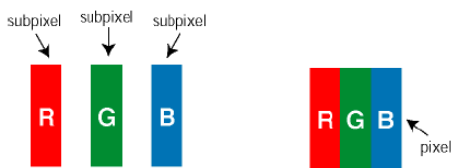

Types of Pixel Defects + Dot definition

Pixel and sub-pixel defects appear on the screen in different ways. There are three categories of pixel defects and several types of sub-pixel defects within each category.

Dot definition = What is a defective "Dot" ?:

One or more defective, adjacent sub-pixel are defined as one "dot". The no. of defective sub-pixels are not relevant to define a defective dot. This means that a defective dot can consist of one, two or three defective sub-pixels which can be dark or lit.



One dot = One Pixel; consists of three sub-pixels of Red; Green and Blue

Bright Dot Defects

Bright dot defects appear as pixels or sub-pixels that are always lit or "on". These are the examples of bright dot defects:



One lit red, green or blue sub-pixel	Two adjacent lit sub-pixels: - Red + Blue = Purple - Red + Green = Yellow - Green + Blue = Cyan (Light Blue)	Three adjacent lit sub-pixels (one white dot)
--------------------------------------	---	---

Dark Dot Defects

Black dot defects appear as pixels or sub-pixels that are always dark or "off". These are the examples of black dot defects:

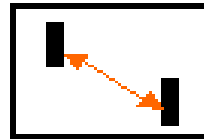
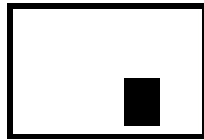

One dark dot	Two adjacent dark dots= 1 pair of dark dots	Two dark dots, specifications defines the minimum distance between dark dots
--------------	--	--

Proximity of Pixel Defects

Because pixel and sub-pixels defects of the same type that are nearby one another may be more noticeable, Philips also specifies tolerances for the proximity of pixel defects. In the table below you can find specifications about:

- Allowed amount of adjacent dark dots = (adjacent dark dots = 1 pair of dark dots)
- Minimum distance between dark dots
- Total no. of all defective dots

Pixel Defect Tolerances

In order to qualify for repair due to pixel defects during the warranty period, a PDP / TFT panel in a Philips Plasma / LCD-display must have pixel or sub-pixel defects exceeding the tolerances listed in the following table.

BRIGHT DOT EFFECT	ACCEPTABLE LEVEL
MODEL	BDL4251V
1 lit sub pixel	1
BLACK DOT EFFECT	ACCEPTABLE LEVEL
1 dark sub pixel	8
TOTAL DOT DEFECTS OF ALL TYPES	9

Note:

* 1 or 2 adjacent sub pixel defects = 1 dot defect

Features

Full HD LCD display 1920x1080p

This display has a resolution that is referred to as Full HD. The state-of-the-art LCD screen technology has the full high-definition widescreen resolution of 1080 progressive lines, each with 1920 pixels. This allows the best possible picture quality for HD input signals with up to 1080 lines. It produces brilliant flicker-free progressive scan pictures with optimum brightness and superb colors. This vibrant and sharp image will provide you with an enhanced viewing experience.

Slim bezel

A slim bezel design adds a stylish look to a public display to nicely blend in most environments. Furthermore this design is ideal for tiled matrix video walls.

Zoom function for tiled matrix

The internal zoom function enables easy implementation of a video wall matrix, without the need for expensive external equipment. Capable of a vidiwall of 25 displays by dividing up to 5 displays each horizontally and vertically.

High brightness

Allows daylight viewing even in large public environments with high ambient light conditions due to its 700 cd/m² high brightness professional panel.

Network controllability: RS232C

Network controllability allows user to control and adjust monitors remotely through RS232C protocol.

Smart insert

Professional PC's are part of most public signage installations. Quite often they add additional depth to the public display and a lot of cable clutter. This public display contains a Smart insert in the backcover that will fit many professional small form factor PC's. In addition it offers provisions for efficient cable management.

SmartPower

The backlight intensity can be controlled and pre-set by the system to reduce the power consumption by up to 50%, which saves substantially on energy costs.

Advanced anti image sticking

Static images left on-screen for extended periods of time may leave a "ghost image" or image sticking effect on LCD displays. Although image sticking in LCD displays is not permanent, you want to prevent this to happen, especially in locations where content is shown 24/7.

Compliant with RoHS standards

Philips designs and produces display products in compliance with strict Restriction of Hazardous Substances (RoHS) standards that restrict lead and other toxic substances that can harm the environment.

Automatic Long Cable Compensation:

Automatic long cable compensation prevents image quality degradation (color shift and dull signals) caused by long cable lengths.

Troubleshooting

No picture

- The signal cable should be completely connected to the graphics card/computer.
- Front Power Switch and computer power switch should be in the ON position.
- Check to make sure that a supported mode has been selected on the graphics card or system being used. (Please consult graphics card or system manual to change graphics mode.)
- Check the monitor and your graphics card with respect to compatibility and recommended settings.
- Check the signal cable connector for bent or pushed-in pins.
- If nothing is displayed on the screen when HDCP device is connected, reset the power of the device.

Power Button does not respond

- Unplug the power cord of the monitor from the AC outlet to turn off and reset the monitor.

Image persistence

- Please be aware that LCD Technology may experience a phenomenon known as Image Persistence. Image Persistence occurs when a residual or “ghost” image of a previous image remains visible on the screen. Unlike CRT monitors, LCD monitors’ image persistence is not permanent, but constant images being displayed for a long period of time should be avoided. To alleviate image persistence, turn off the monitor for as long as the previous image was displayed. For example, if an image was on the monitor for one hour and a residual image remains, the monitor should be turned off for one hour to erase the image.

NOTE:

As with all personal display devices, PHILIPS recommends displaying moving images and using a moving panel saving at regular intervals whenever the screen is idle or turning off the monitor when not in use.

Image is unstable, unfocused or swimming is apparent

- Signal cable should be completely attached to the computer.
- Use the OSD Image Adjust controls to focus and adjust display by increasing or decreasing the fine adjustment. When the display mode is changed, the OSD Image Adjust settings may need to be re-adjusted.
- Check the monitor and your graphics with respect to compatibility and recommended signal timings.
- If your text is garbled, change the video mode to non-interlace and use 60 Hz refresh rate.

Image of component signal is greenish

- Check to see if the COMPONENT input connector is selected.

LED on monitor is not lit (no green or red color can be seen)

- Power Switch should be in the ON position and power cord should be connected.
- Make certain the computer is not in a power-saving mode (touch the keyboard or mouse).

RED LED on monitor is blinking

- A certain failure might have occurred, please contact your nearest authorized PHILIPS service facility.

Display image is not sized properly

- Use the OSD Image Adjust controls to increase or decrease the coarse adjustment.
- Check to make sure that a supported mode has been selected on the graphics card or system being used. (Please consult graphics card or system manual to change graphics mode.)

Selected resolution is not displayed properly

- Use OSD Display Mode to enter Information menu and confirm that the appropriate resolution has been selected. If not, select corresponding option.

No Sound

- Check to see if speaker cable is properly connected.
- Check to see if mute is activated.
- Check to see if volume is set at minimum.

Remote Control does not work

- Check the Remote Control's batteries status.
- Check if batteries are inserted correctly.
- Check if the Remote Control is pointing at the monitor's remote sensor.

“SCHEDULE” / “SLEEP TIMER” function is not working properly

- The “SCHEDULE” function will be disabled when the “SLEEP TIMER” is set.
- If the “SLEEP TIMER” function is enabled and the power to the LCD monitor is turned off if the power supply is interrupted unexpectedly, then the “SLEEP TIMER” will be reset.

Stripe Noise

Either light vertical or horizontal stripes may appear, depending on the specific display pattern. This is no product fault or degradation.

“NO SIGNAL” is displayed on the screen

Image may not be displayed right after HDCP device is connected.

Specifications

Specifications (BDL4251V)

Product Specifications		Analog Input	Digital Input
LCD Module	Diagonal: Pixel Pitch: Resolution: Color: Brightness: Contrast Ratio: Response time: View Angle:	42" / 106.7 cm 0.485 mm 1920 x 1080 dots 1.07 billion colors (depending on video card used) 700 cd/m2 (typ.) 1,000:1 (typ.) , 3,000:1 with Smart Contrast 9 ms (typ. G to G) Up and Down 178°, Left and Right 178° (typ.) @CR>10	
Frequency	Horizontal: Vertical:	15.625 / 15.734, 31 - 91 kHz 50.0 / 58.0 - 75.0 Hz	
Pixel Clock		13.5 -165.0 MHz	25.0 -165.0 MHz
Viewable Size		930.25 x 523.25 mm / 36.6 x 20.6 inches	
Input Signal			
PC-Input:	Video:	Analog RGB Video: 0.7 Vp-p Input impedance 75 ohm	TMDS
VIDEO Input:	Sync: Input-terminal:	Separate HV sync: TTL level (Pos./Neg.),Input Impedance 2.2K ohm 15 Pin Mini D-sub Composite: 1.0 Vp-p Input impedance 75ohm BNC and RCA-PINJACK-INPUT Y/C Y: 1 Vp-p C: 0.286 Vp-p Input Impedance 75 ohm S-TERMINAL-INPUT Component: 1.0 / 0.7 Vp-p Input Impedance 75 ohm BNC-INPUT	HDMI
AUDIO Input: RS232C:	In:	RCA PIN-JACK L/R INPUT x 2, STEREO Mini Jack INPUT x 1 9 Pin Mini D-sub	
Output Signal			
PC-Output:	Video: Sync: Output-terminal:	Analog RGB Video: 0.7 Vp-p with 75 ohm terminated Separate HV sync: TTL level (Pos./Neg.) 15 Pin Mini D-sub	
VIDEO Output: AUDIO Output: Speaker Output:		BNC-OUTPUT x 1, Composite 1.0 Vp-p with 75 ohm terminated RCA PIN-JACK L/R OUTPUT x 1, 0.15 Vrms with 47k ohm terminated Internal Speaker 5 W + 5 W (8 ohm) External Speaker Jack 7 W + 7 W (8 ohm)	
RS232C:	Out:	9 Pin Mini D-sub	
Resolutions Supported		640 x 480 at 60 Hz 800 x 600 at 60Hz 1024 x 768 at 60Hz 1280 x 720 at 60Hz 1280 x 768 at 60Hz 1360 x 768 at 60Hz 1600 x 1200 at 60 Hz 1900x1200 (reduced Blanking only) 1920 x 1080 at 60Hz* * Recommended Resolution NTSC,PAL,SECAM,4.43NTSC,PAL60 DVD:480i,480p, 576i,720p,1080i,1080p	
Power Supply		2.4 – 1.2 A @100 - 240 V AC, 50 ~ 60 Hz	
Power Consumption	Power Save:	Typically 232 W Less than 1W (Power button off or main power switch off.)	
Operational Environment	Temperature: Humidity:	Landscape: 5 - 40 °C / 41-104 °F, Portrait : 5 - 35 °C / 41 - 95 °F 20 - 80 % (Without condensation)	
Storage Environment	Temperature: Humidity:	-20 - 60 °C / -4 - 140 °F 10 - 90% (Without condensation)/90%-3.5%(Temp-40°C) regarding over 40°C	
Dimension	Net without stand: Net with stand: Gross:	967.6 mm (W) x 559.6 mm (H) x 123.1mm (D) / 38.09" (W) x 22.03" (H) x 4.85" (D) 967.6 mm (W) x 605.6 mm (H) x 405 mm (D) / 38.09" (W) x 23.84" (H) x 15.95" (D) 1170 mm (W) x 715 mm (H) x 286 mm (D) / 70.87" (W) x 28.15" (H) x 11.26" (D)	
Weight	Net without stand: Net with stand: Gross:	48.5lbs / 22 kg 52.47 lbs / 23.8 kg 68.78 lbs / 31.2kg	
Wall mounting interface		8 Holes (400 mm pitches) Optional Multi-purpose Fix Mount	
Complied Regulatory and Guidelines		UL60950-1/C-UL/EN60950-1/FCC-B/EN55022-B/EN55024/EN61000-3-2/EN61000-3-3 /CE	
Power Management		Support VESA DPMS convention	
Plug & Play		VESA DDC2B, DDC/CI	
Accessories		CD User's Manual, QSG, Power Cord, VGA Cable, BNC TO RCA adapter x 5, Remote Controller, AAA Battery x 2, Clamper x 2 (To prevent from falling), Cable belt x 3 (For securing cables), Screw for Main switch cover x 2, Screw for CLAMPER x 2, Cable Holder x 2, Main switch cover.	

Note: Technical specifications are subject to change without notice.

Pin Assignment

1) Analog Video Signal Input (Mini D-SUB 15P): VGA

Pin No	Name
1	Video Signal Red
2	Video Signal Green
3	Video Signal Blue
4	GND
5	DDC-GND
6	Red-GND
7	Green-GND
8	Blue-GND
9	+5V (DDC)
10	SYNC-GND
11	GND
12	DDC-SDA
13	H-SYNC
14	V-SYNC
15	DDC-SCL

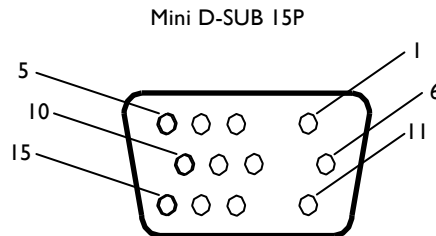

2) S-VIDEO input (MINI DIN 4P): S-VIDEO

Pin No	Name
1	GND
2	GND
3	Y (Luminance)
4	C (Chroma)

MINI DIN 4P

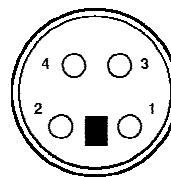

3) HDMI:

Pin - Assignment of HDMI connector:					
1	TMDS Data2+	8	TMDS Data0 Shield	15	SCL
2	TMDS Data2 Shield	9	TMDS Data0-	16	SDA
3	TMDS Data2-	10	TMDS Clock+	17	DDC/CEC Ground
4	TMDS Data1+	11	TMDS Clock Shield	18	+5V Power
5	TMDS Data1 Shield	12	TMDS Clock-	19	Hot Plug Detect
6	TMDS Data1-	13	CEC		
7	TMDS Data0+	14	Reserved (N.C. on device)		

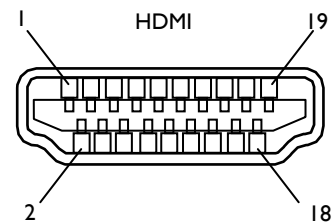

4) RS232C input/output

Pin No	Name
1	NC
2	RXD
3	TXD
4	NC
5	GND
6	NC
7	RTS
8	CTS
9	NC

Mini D-SUB 9P

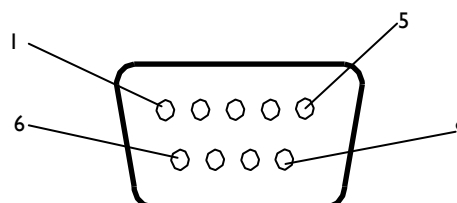

Specifications are subject to change without notice.

www.philips.com